

electronics

radio, sound, communications and industrial applications
of electron tubes • • • design, engineering, manufacture

Binaural
reception

+

Synchronous
broadcasting

+

Electronic
control in a
tube plant

+

Photoelectric
color matchers

+

"Speech radios"
versus
"music radios"

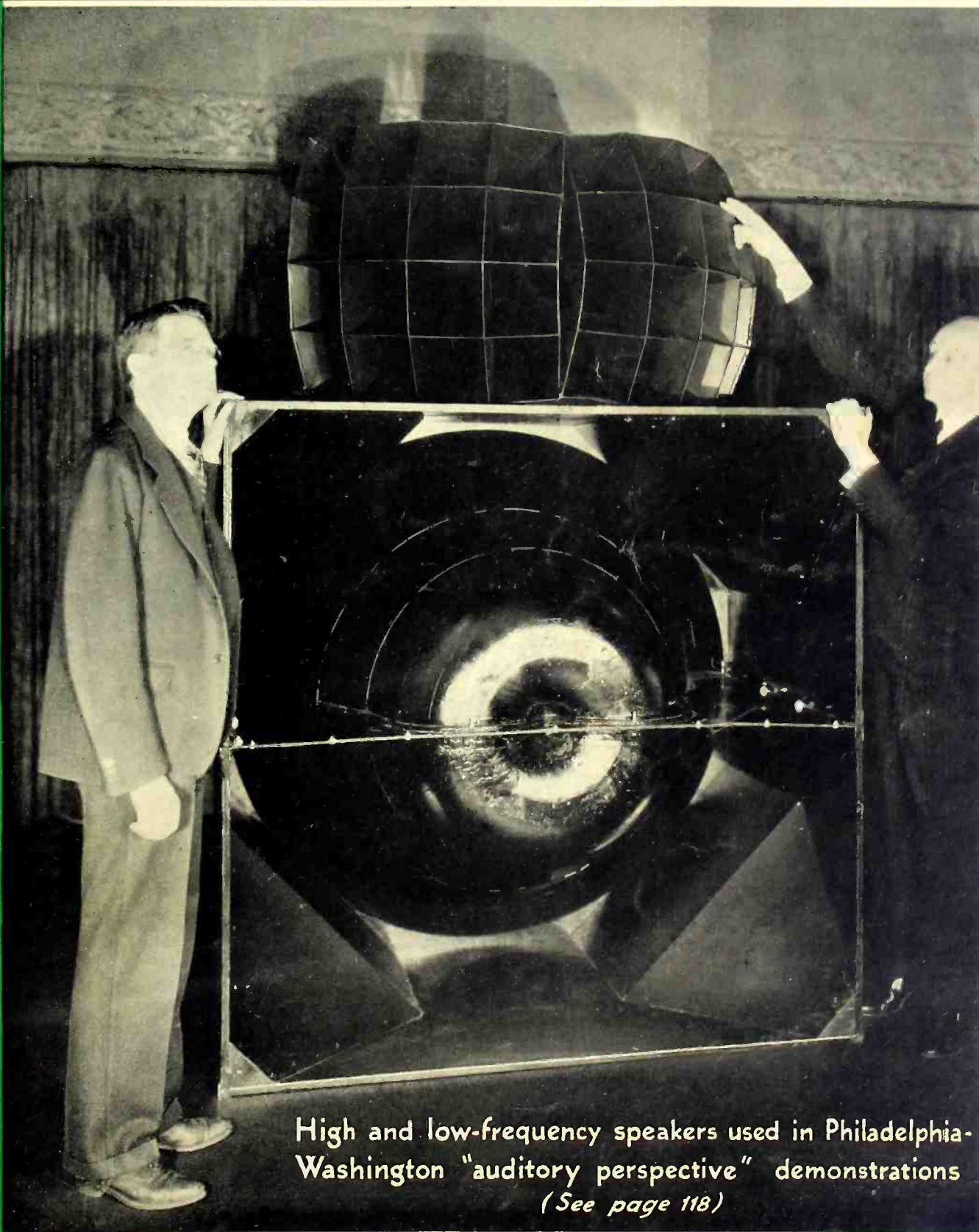

High and low-frequency speakers used in Philadelphia-Washington "auditory perspective" demonstrations
(See page 118)

McGRAW-HILL PUBLISHING COMPANY, INC.

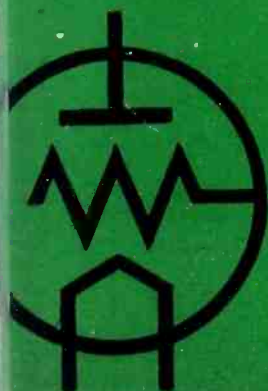

Price 35 Cents

MAY, 1933

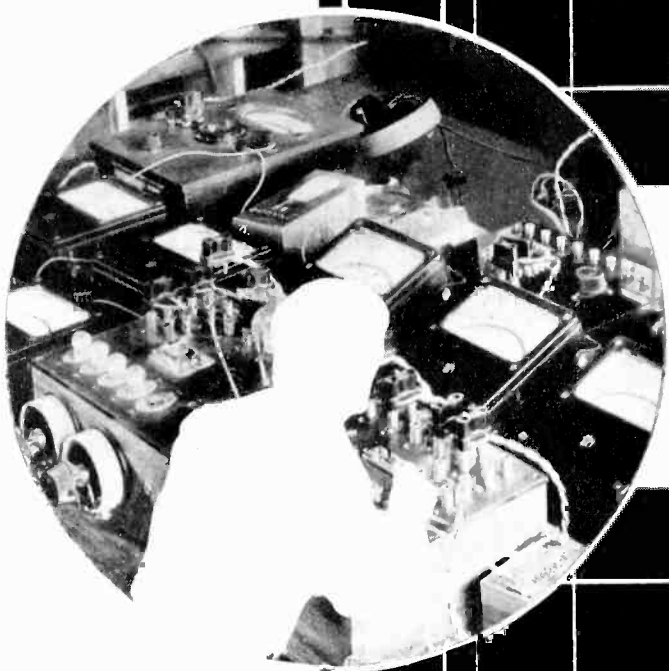

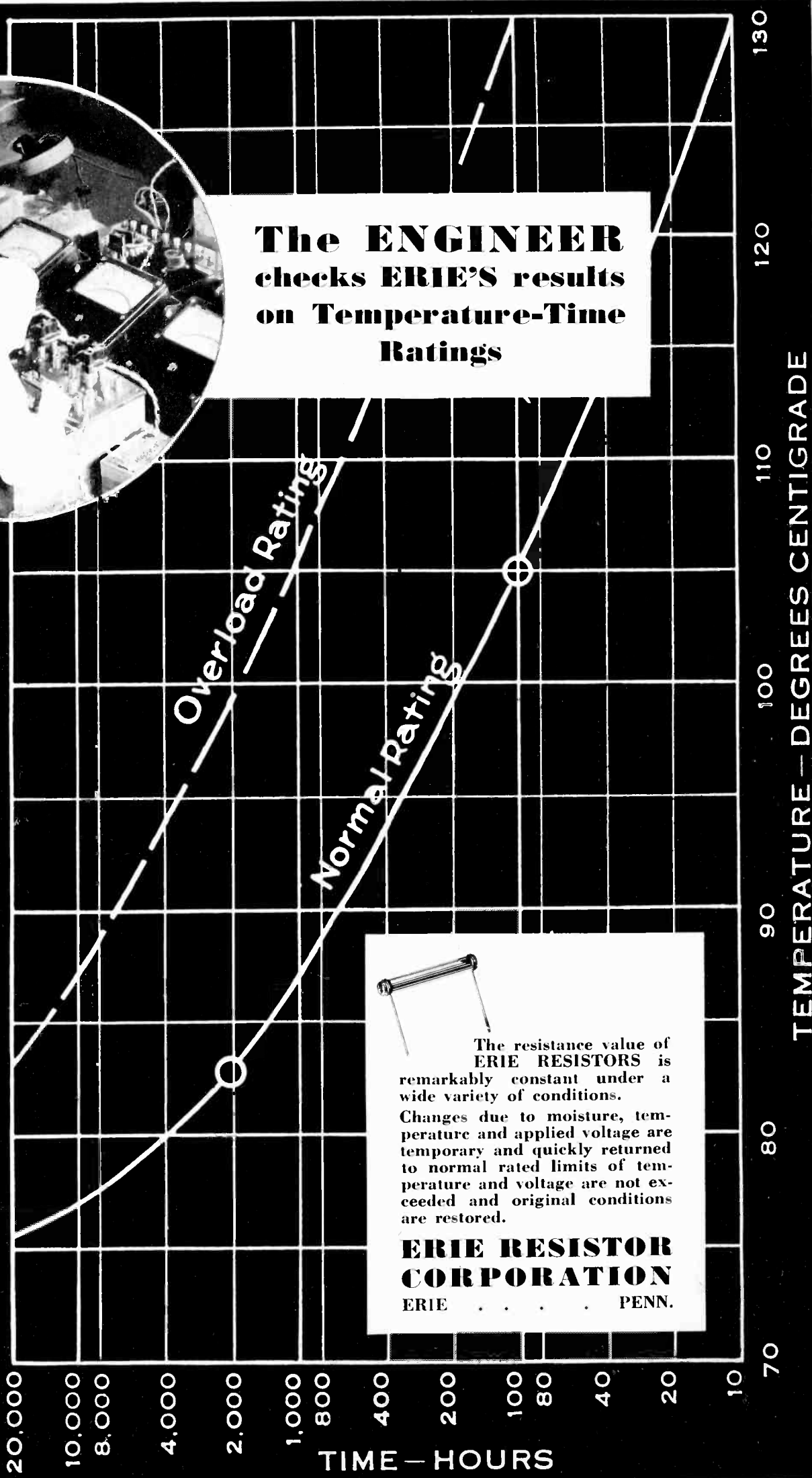

**The ENGINEER
checks ERIE'S results
on Temperature-Time
Ratings**

The resistance value of ERIE RESISTORS is remarkably constant under a wide variety of conditions. Changes due to moisture, temperature and applied voltage are temporary and quickly returned to normal rated limits of temperature and voltage are not exceeded and original conditions are restored.

ERIE RESISTOR CORPORATION
ERIE PENN.

electronics

O. H. CALDWELL
Editor

KEITH HENNEY
Associate Editor

McGRAW-HILL PUBLISHING COMPANY, INC.

Vol. 6, No. 5. New York, May, 1933

Big Radios— Little Radios

Tell the public the difference!

THE public is now being offered radio sets at prices all the way from \$12 to \$400. Is it any wonder that the man or woman ready to buy a set, stands confused by this wide range of prices? The advertisements call them all "radio sets," and there has been little to make clear to the public the wide difference in the service they deliver. Let's make the difference clear.

The little "pee-wees," the cigar-box models, the midgets, the personal radio sets, all bring in voice, speeches, news, etc., distinctly and understandably, even if (as in a telephone) the full tones are missing. So let's classify that whole group of little sets as "speech radios." And let's enthusiastically sell and recommend these little sets—these "speech radios" for use where voice and speech are chiefly to be received.

BUT if the customer wants to listen to music—to the great singers, to the great symphonies, to jazz orchestras, or to a brass band—then there is no question that he needs a *musical instrument*, a *musical reproducer*—a "music radio." Every living-room, every home, needs a "music radio" to bring the great music that is on the air, and which the broadcasters have spent so much to transmit with complete fidelity.

If radio manufacturers who make a full-line covering both classes—if radio dealers who sell the full range—will set up this classification and distinction in their minds, in their advertising, their selling, their sales presentation, and their demonstrations, the public will soon become relatively conscious of "speech" radios and "music" radios.

"SPEECH radios," personal radios, will then go ahead to widening usefulness. On the other hand, the market for quality receivers—"music radios,"—will be preserved, for the future of musical enjoyment in the American home.

radio
sound
pictures
telephony
broadcasting
telegraphy
counting
grading
carrier
systems
beam
transmission
photo
cells
facsimile
electric
recording
amplifiers
phonographs
measurements
receivers
therapeutics
traffic
control
musical
instruments
machine
control
television
metering
analysis
aviation
metallurgy
beacons
compasses
automatic
processing
crime
detection
geophysics

TRANSMIT "AUDITORY

Three-channel Philadelphia-Washington circuit
creates striking illusion of reality in placement

AUDITORY perspective" by which the sounds of the instruments in a great orchestra seemed to come from different sides of an empty stage, exactly as if the orchestra itself were seated on that stage, instead of being in another city 150 miles away, was the striking feature of the Bell Laboratories transmission of Dr. Stokowski's Philadelphia orchestra to the audience of the National Academy of Sciences, meeting in Washington, April 27.

In addition, new extensions of the frequency band were transmitted, including tones from 40 cycles to 16,000 cycles per second, affording new degrees of utter realism, in the reproduction of wind instruments, bells, snare-drums and other effects.

Tremendous augmentation of the orchestra's own full volume, even to intensities as high as ten times the volume of the orchestra itself, was also demonstrated, with Dr. Stokowski himself at the controls in the receiving auditorium at Washington, thus introducing a new factor in emotional and musical response to whispering pianissimi and thunderous crescendos.

"Stereoscopic hearing"

With such equipment, explained Dr. Frank B. Jewett, president of the Bell Telephone Laboratories, a musical director may produce at one or more distant points a completely faithful replica of the tonal effects produced locally in the auditorium in which his orchestra is performing. Auditory perspective, which increases the reality of the effect, much as the stereoscope improves a flat panorama, is also available to give a complete illusion of the actual presence of the orchestra at the distant points.

The new system differs from those hitherto familiar, not only in its greatly increased range of tone and loudness compared with the average sound-picture installation (40 to 45 decibels), but in its use of three separate transmission channels. Beginning at microphones in the city of origin of the music, suspended at right, center and left of the orchestra, each channel passes through its own amplifiers and telephone line

to a loud speaker similarly placed on the stage of the auditorium in the distant city where the music is received. How this arrangement enables the distant audience to sense the location of instruments on the stage was explained by Dr. Jewett from its approximation to a sound-proof curtain containing a number of holes. Were the number great this set-up would approach that of a gauze curtain which, if let down between the audience and the orchestra, would not interfere with their usual sense of perspective. As the holes, in imagination, coalesce into three large openings it is not hard to believe that the sense of position will persist. Actual tests have amply confirmed the theory.

Fidelity and volume range

To emphasize the importance of tonal range Dr. Jewett discussed the sounds produced by orchestral instruments. From the bass viol with its lowest note at 40 cycles per second, to the snare drum, violin and oboe whose highest overtones reach 16,000, is a range of eight and a half octaves. Were the lower end of this range cut off, the music would sound thin and "tinny," while the upper end contributes the crispness and brilliance that is necessary for complete illusion.

Of equal importance to an orchestral leader is the ability to deliver an ample volume of sound; in fact the largest orchestra (70 decibels) is occasionally inadequate for climactic effects. The electrical system therefore was designed for a sound output up to 80 decibels,—ten times as great as that of a full orchestra. The pianissimo passages of a violin are about one-hundred-millionth as loud, and since they must not be marred by noise picked up during transmission, a rigorous requirement for quietness was placed on the electrical system. So well has this been met by engineers of Bell Telephone Laboratories that during silent intervals the sound output of the loud speakers is only one three-hundredth of that heard by a motion-picture audience during the silent moments of the best films.

Starting with the dynamic microphones hung a short distance in front of the stage in the American Academy

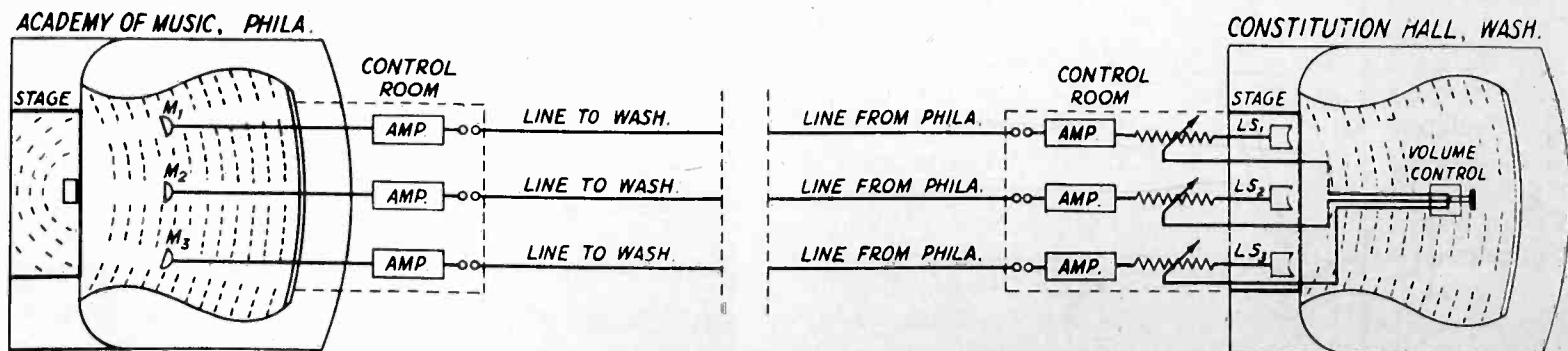

Diagram showing arrangement of the three microphones in Philadelphia, amplifiers, telephone channels, and Washington amplifiers and loudspeakers on stage of Constitution Hall

PERSPECTIVE" IN MUSIC

Bell Laboratories cooperate with Dr. Stokowski's orchestra in 16,000-cycle fidelity at ten-fold volume



Dr. Frank B. Jewett and Dr. Harvey Fletcher of the Bell Laboratories with one of the low-frequency speaker diaphragms

of Music in Philadelphia, from which the music was transmitted, Dr. Jewett described the amplifiers in that building. Particularly important are the method and the equipment used for long-distance transmission by wire to Washington. The carrier-current method was used, and transmission was by underground cable throughout. Intermediate amplifiers were located at five points en route. To raise the output of the microphones to the level required for the loud speakers, and to make up for line losses, a total amplification of a million million million million (10^{24}) times was required.

Providing the large sound output for the heavy low notes, one loudspeaker unit of enormous size was used on each channel, and two smaller ones were used to radiate the higher notes. Each of the high-frequency speakers has a 16-cell 60-degree diffuser, to distribute the sound output over a greater angle, (see front cover), giving a total of 120 degrees. The combination has an output capacity of 80 watts for the higher range and 200 watts for the lower. E. C. Wentz and A. L. Thuras of the Bell Laboratories are shown in the front-cover picture.

In contrast to the practice in broadcasting and phonograph recording this system places no restrictions on an orchestra or its leader. Volume controls are available to the director who sits with the audience at the receiving point, but these are used to secure certain tonal effects rather than to "compress" the volume to a range which can be transmitted and handled by receiving sets.

Acknowledging indebtedness to Dr. Leopold Stokowski, director of the Philadelphia Orchestra, Dr. Jewett said:

"During the course of investigations carried on in Bell Telephone Laboratories, we had developed telephonic systems of high quality, but for further researches we needed opportunity to utilize music in its most perfect forms. Now it happened that Dr. Stokowski was interested in the possibilities of electrical systems for the production of exceptional orchestral effects. Through his voluntary cooperation, therefore, the Laboratories' scientists were able to make quantitative physical studies of music as rendered by his orchestra, and so to perfect their designs; and with the completion of the new equipment some of the possibilities which Dr. Stokowski had hoped for have become practicable."

Experiments demonstrate sound placement

The remarkable "auditory perspective" or sense of location of individual sound sources on the empty stage, was strikingly demonstrated by several other experiments performed over the three-channel transmission. These experiments actually originated in Philadelphia, but were observed by the audience at Washington, and were interpreted there by Dr. Harvey Fletcher.

On the stage of the Academy of Music at Philadelphia, where the pickup microphones were installed, a workman busily constructing a box with hammer and saw was heard receiving suggestions and comments from a

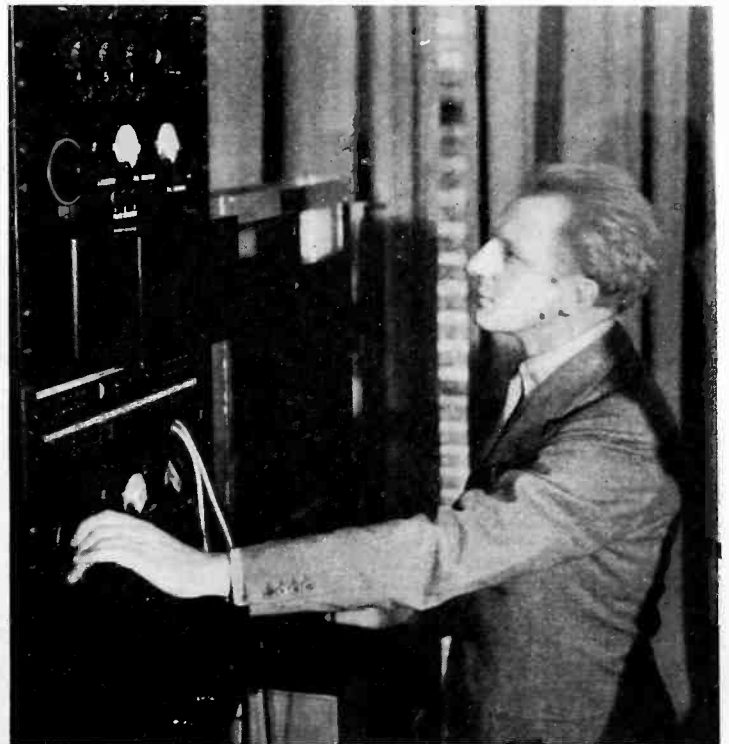

Dr. Leopold Stokowski, director of the Philadelphia Orchestra, at one of the Washington amplifiers

fellow workman in the right wing. All the speech and accompanying sounds were transmitted over cable circuits to the loud speakers on the stage of Constitution Hall in Washington. So realistic was the effect that to the audience the act seemed to be taking place on the stage before them. Not only were the sounds of sawing, hammering and talking faithfully reproduced, but the correct auditory perspective enabled the listeners to place each sound in its proper position, and to follow the movements of the actors by their footsteps and voices.

For another demonstration, the audience heard a soprano sing "Coming Through the Rye" as she walked back and forth through an imaginary rye field on the stage in Philadelphia. Here again her voice was reproduced in Washington with such exact auditory perspective that the singer appeared to be strolling on the stage of Constitution Hall.

An experiment which demonstrated both the complete fidelity of reproduction and the effect of auditory perspective was performed by two trumpet players. One, in Philadelphia at the left of the stage of the Academy of Music, and the other in Washington at the right of the stage of Constitution Hall but invisible to the audience, alternately played a few phrases of the same selection. To those in the audience there seemed to be a trumpet player at each side of the stage before them. It was not until after the stage was lighted that they realized that only one of the trumpet players was there in person. The music of the other was transmitted from Philadelphia with such perfect fidelity and reproduced in such true perspective that it was impossible to tell one of the players was absent.

The auditory perspective effect is not restricted to placing sounds in their correct positions across the stage, but is three dimensional. This was shown by having several sources of sound (such as sleigh-bells) moved around the stage in Philadelphia, not only back and forth but high up in the center of the stage as well. The movement of each sound was faithfully reproduced by the speakers high above the level of the stage floor.

Dr. Stokowski pictures the possibilities

In commenting on the transmission of music and its future opportunities, Dr. Stokowski said:

"One element in all scientific progress is its application to our life. Here, in my opinion, this new method of conveying sound to many other places over great distances without distortion or electrical disturbance or static—is of national importance. For example there are symphony orchestras in only about ten or fifteen cities in the United States and there are thousands of other cities or towns with no orchestra. At the same time the cities which have the orchestras are at the present time finding it difficult to support them.

"By this method, cities like Cleveland, or Detroit or Chicago, for example, which have fine symphony orchestras, could send out to all the neighboring towns and cities within a generous radius, the symphonic music they create, so that in all these towns and cities music lovers can hear the music exactly as in the original. This will enable the city having the orchestra to enlarge its public and improve its orchestra in quality, and will enable other cities which have at present no orchestras, to create them and send out their music to neighboring towns and cities without distortion or any lowering of quality.

"By this means we could zone the whole country and have a first class symphonic orchestra in the most important city of each zone, thus giving variety to our music—more opportunity to the generation of American musicians now growing up—more opportunity for the American composer to have his work heard—more opportunity to the new generation of American conductors—and more opportunity to the music lover to hear many types of music variously played, and by comparison of these different methods, less standardization and more individuality.

"By all these means wired transmission can enrich our musical life—reaching the most remote parts of the North American continent."

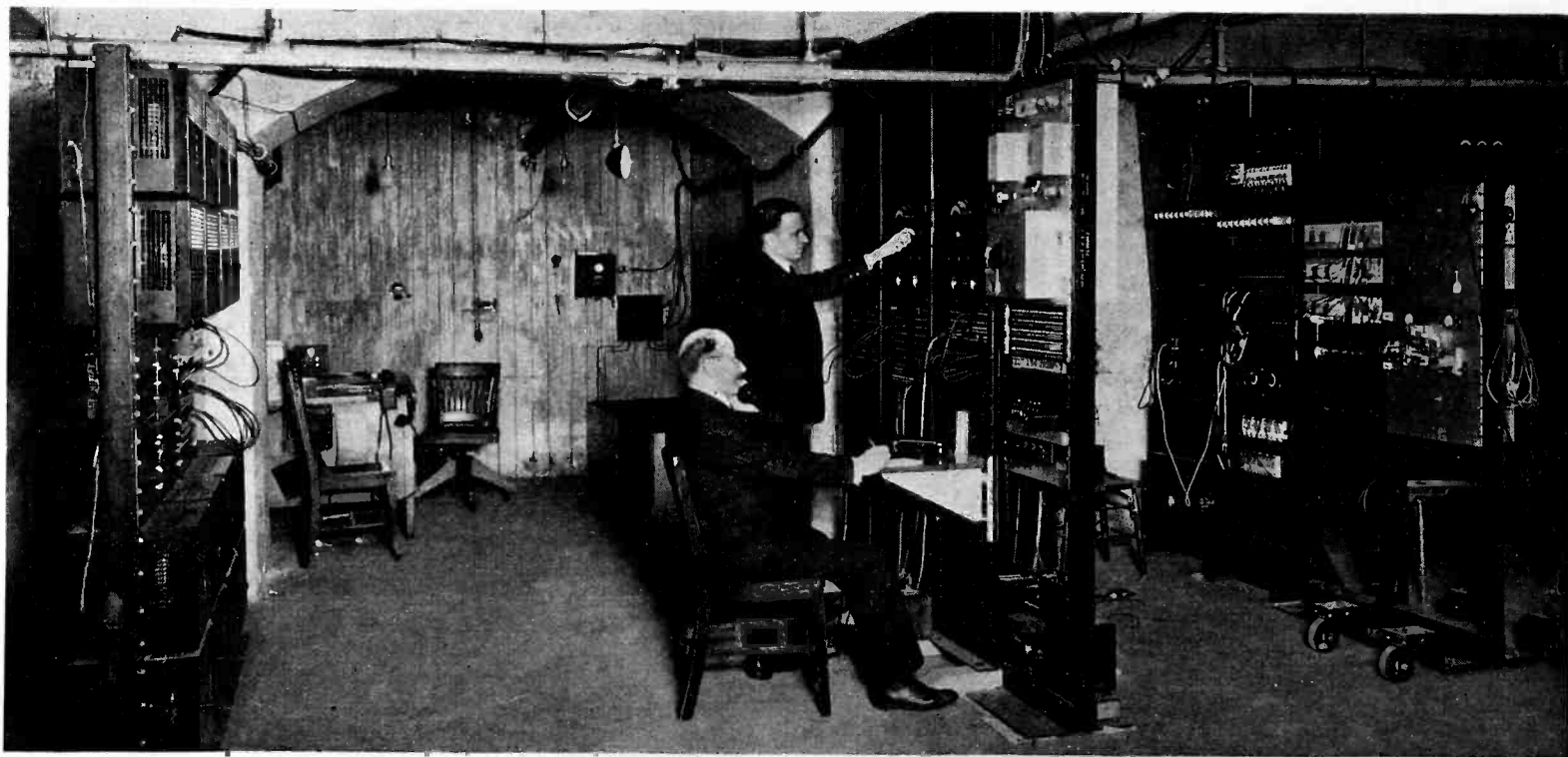

The control room and transmitting amplifiers in the basement of the Philadelphia Academy of Music. During the demonstration, the Philadelphia orchestra played on the stage of this building, while Dr. Stokowski sat with the Washington audience and manipulated the volume levels there

The role of vacuum-tubes in a tube factory

By W. P. KOECHEL
The Ken-Rad Corporation

VACUUM tubes are finding an increasing use in all branches of industry. It is not strange, therefore, that they also find wide use in a tube factory where electronic circuits of some sort or another enter into almost every operation. It may be of interest to describe some of the applications to which electronic circuits are put in the Ken-Rad plant. Although only the more recent applications will be described, a list is included of various others. Some of them have been previously described, some are common knowledge and others are new. Electronic tubes play the major role in each of the following circuits or devices: supervision of all factory d-c voltage lines (*Electronics*, December, 1932, page 418); temperature control of electric coating ovens (*Electronics*, May, 1932, page 170); automatic cathode-heating time indicator (*Electronics*, September, 1932, page 293); delayed time circuit on life test rack to delay application of plate voltage until after tube cathodes have heated; voltmeters for measuring peak voltages and currents; oscillators for bombardiers; amplifiers for leak detectors, noise tests, wave form analysis, impedance bridges, etc.; rectifiers in a.c.-d.c. circuits for supplying test voltages; Pirani gage alarm indicator for change of air pressure of 1 micron; mutual conductance measuring (described here); timing circuit for controlling time of spray application of cathode coating (described here); meter protective circuit for sensitive meters (described here), and automatic control of output of d-c generators.

Measuring low values of Gm

When amplifier tubes are operated under cut-off conditions, Gm is often as low as 1 micromho, and therefore difficult to measure by either bridge or direct reading meter methods. The following circuit, however, permits of accurate measurements down to 1 micromho.

Fundamentally the principle of measuring Gm involves the measurement of small changes of plate current caused by small changes in grid voltage. By definition this becomes $G_m = \frac{i_p}{e_g}$. These changes in grid

voltages may be either d.c. or a.c. If a.c., they will cause an a.c. component of current to be present in the d.c. plate current of the tube.

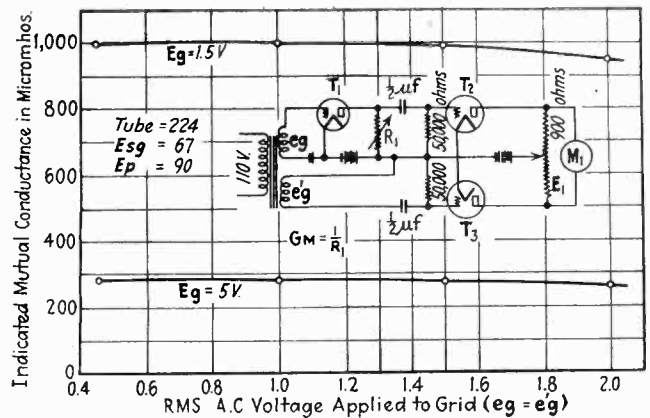

Fig. 1—Circuit of Gm-meter and measurements made on screen-grid tube

It is important in actual measuring circuits to use not more than 1 volt for the applied grid increment or signal. A larger value than this causes harmonics in the a.c. component of the plate current and appreciable error in indicated Gm. Therefore, we are limited to a voltage value of not more than 1 volt for e_g (even less for some types of tubes). If this value of grid voltage is applied to a tube with a Gm of 1,000, there will be exactly 1 ma. change or 1 ma. a.c. component in the plate circuit of the tube. This amount is comparatively easy to detect in a number of ways, including the dynamic meter method and bridge method. However, when we get to lower values of Gm. (such as required under cut-out condi-

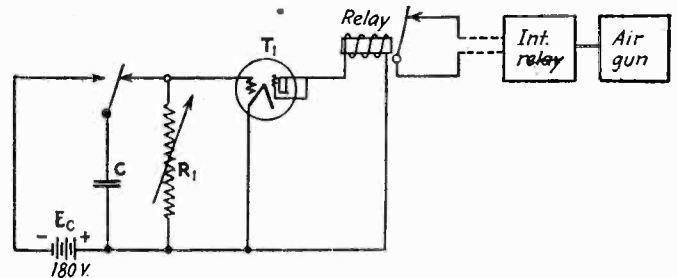

Fig. 2—Circuit for automatically controlling cathode spray gun

tions), the corresponding plate current change for a 1-volt grid change is extremely small. For instance, for a Gm. of 1 micromho we would have only 1 μ amp. change, or 1 μ amp. a.c. component in the plate circuit. There are at present no suitable meters available for measuring a.c. currents of such small orders. Any scheme for accurately measuring low values of Gm will, therefore, necessarily involve using amplification.

If it were possible to use a distortionless amplifier with an overall current amplification of 100 connected ahead of a direct-reading Gm meter, we would have the required sensitivity, but this would necessitate having an accurately calibrated amplifier, such that the overall amplification was at all times maintained at exactly 100. At present this is not practical.

The circuit to be described makes use of amplification, but uses two tubes in such a way that all variables of plate voltage and applied signal voltage are cancelled out and do not affect the final reading. Figure 1 shows the circuit. R_1 is calibrated directly; T_2 and T_3 represent tubes matched with respect to impedance and plate current (UY-237). The voltages e_g and e_g' are equal. This can be accomplished either by using a center-tap resistor, or two separate windings of equal value.

With an a.c. signal e_g applied to the grid of tube T_1 , the following relations obtain

$i_p = e_g Gm$. If R_1 is adjusted so that $e_p = e_g' = i_p R_1$

$$e_g = i_p R_1 \quad \text{Then } Gm = \frac{i_p}{e_g} = \frac{i_p}{i_p R_1} = \frac{1}{R_1}$$

Thus it will be seen that regardless of the values of e_g (providing $e_g = e_g'$) Gm will be given by $1/R_1$. If desired e_g' can be made to equal $e_g/10$, in which case the indicated reading on the calibrated dial of R_1 must be divided by 10. This will permit using a lower value of R_1 with a consequent lower error correction.

The equalizing of the voltages e_g and e_g' is accomplished by using a push-pull amplifier, as shown. The microammeter M will indicate any difference in plate current between the two tubes T_2 and T_3 , caused by applications of unequal voltage values to the two grids. With potentiometer E_1 properly adjusted and no a.c. signal applied to either grid, the microammeter will show zero reading. This zero reading will not be affected if a.c. signals of equal amplitude (and equal phase) are applied to each grid. Therefore, the only indication which will show up on the meter is the difference in plate current between the two tubes caused by signals of *unequal amplitude* being applied to the grids of T_2 and T_3 . When R_1 is adjusted so that the voltage across it is equal to e_g' ,

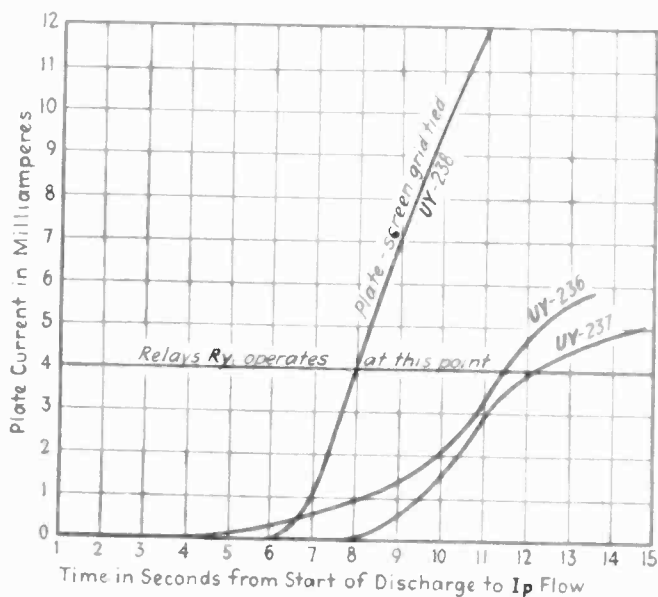

Fig. 3—Sharp cut-off of 238 compared to other tubes for use in spray-gun circuit

there will be signals of equal amplitude applied to the grids of tubes T_2 and T_3 and give a zero reading on the microammeter. Under these conditions, readings on the calibrated dial of R_1 give a direct indication of Gm .

Variations of amplifier plate voltage will not affect the balance point of R_1 , for an increase will give an equal increase of current on both tubes and therefore no indication on M . Furthermore, the potentiometer E_1 is always balanced initially to give a zero setting on M . The amount of plate voltage on the amplifier tubes does, however, affect the sensitivity of the amplifier. The

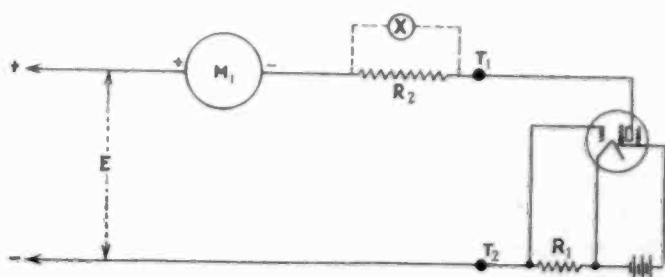

Fig. 4—Protective circuit for sensitive meter—using vacuum tube

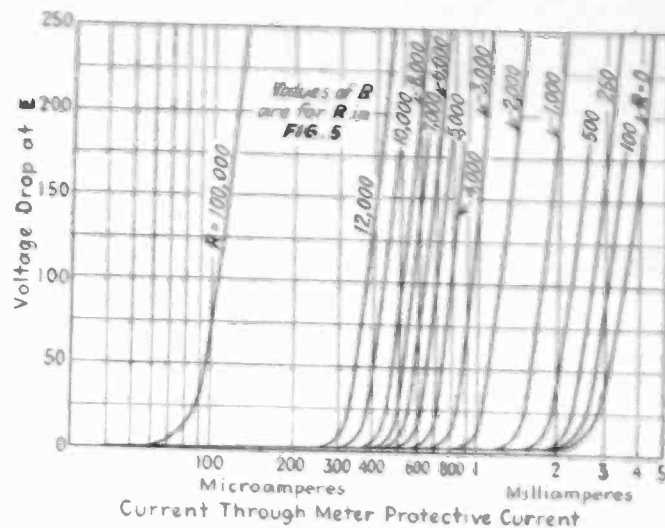

Fig. 5—Current flowing through protective circuit as function of resistance and input voltage

greater this plate voltage the greater the sensitivity and response of the amplifier.

In balancing for a reading, the resistor R_1 is varied until the meter indicates null reading. In other words, the amplifier is always balanced for the final reading by a 1-volt a.c. signal to each grid. If the value of e_g should change any, e_g' will change by an equal amount and the balance will, therefore, be obtained at exactly the same point on R_1 . The results of varying e_g and e_g' simultaneously are shown. It will be noted that the indicated value of Gm did not change appreciably until the signal voltage on the grid exceeded 1.6 volts.

As R_1 is in the plate circuit of the tube, there will be a slight IR drop across it, due to the d.c. plate current through it. For an extremely accurate reading this can be compensated by increasing the plate voltage to give normal plate current reading.

In addition to the inappreciable error caused by the d.c. drop across R_1 there will be a small error caused by the presence of external impedance in the plate circuit.

As indicated, Gm is equal to $\mu/(R_p + R_1)$ it follows that if R_1 is low enough, the error due to it can be neglected. In measuring tubes under cut-off condition, R_1 is by comparison with r_p extremely small, and, therefore, its effect in the circuit will be negligible.

Furthermore, by making $e_g' = e_g/10$, R_1 will be 0.1, the value it would be for $e_g = e_g'$.

The accuracy of indicated mutual conductance when read by the foregoing method will depend entirely on the accuracy of the calibrated resistor R_1 . As the calibrated dial attached to resistor R_1 is merely turned until the meter indicates null, this circuit is almost as fast as a direct-reading meter.

Tube controlled cathode coating

To further improve uniformity of quality of cathode-type tubes it is necessary to have complete control of the application of the cathode coating. Too heavy or too light a coating will each have detrimental effects on the final characteristics of the completed tube. As this coating is applied to the cathode sleeve by means of an air gun, the coating weight will be partially dependent upon the length of time for which the gun is operated. If this time is dependent on an operator's judgment, considerable lack of uniformity will be in evidence. However, by utilizing an automatic timer operating an electric air valve, this human element of error is eliminated.

An automatic timer developed for this purpose makes

it possible to pre-set for any required time between 2 and 20 seconds, as specifications may dictate. If, for instance, the timing dials are set for 7.5 seconds and the starting button is pushed, the spray gun will operate for exactly 7.5 seconds and at the end of that time be automatically shut off.

This device involves no clock work or moving parts and can be made up to operate with an accuracy of 1 per cent. The timing unit is completely assembled into a small cabinet having on the outside two dials calibrated in time values. One dial is calibrated from 2 to 20 seconds in 1-second steps, the other from 0 to 1 second in continuously variable steps. A red and green pilot light are mounted on the panel for monitoring purposes. A push button provides the means for starting the timing circuit. The air supply to the gun is controlled by an electrically operated air valve, which is actuated by the timing circuit. After the cathodes to be sprayed have been placed on a revolving head (in line of fire of the spray gun) the starting button is pushed which starts the timing circuit and actuates the air valve for the proper length of time according to the setting of the dials.

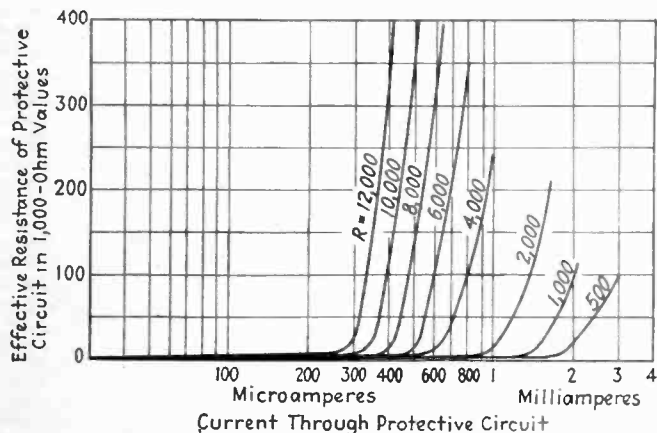

Fig. 6—Effective resistance of protective circuit

The basis of the timing circuit is the *time of discharge of a condenser through a resistor*. The condenser and grid leak are connected across the grid of a tube (see Fig. 2), so that when the condenser is charged a bias voltage will be applied to the grid, which gradually decreases as the condenser discharges through the grid leak. The time of discharge will be entirely dependent on resistor and condenser values and on the value of applied charging voltage. By using a calibrated variable resistor R it is possible to obtain any time value within the range of the resistor. As timing depends only on the values of R , C and E_0 , the accuracy of time values will be governed by the quality and constancy of the resistors and condensers used.

The relay in the plate circuit operates only when one volt or less bias is applied to the grid. Therefore, if the condenser C is charged to 180 volts, it must "leak off" or decrease to one volt before the relay can operate. The time consumed for this discharge from 180 to 1 volt comprises the time element of the circuit.

The tube used for the amplifier is a 238, because the characteristics of this tube permit a very sharp I_p pick up when the bias voltage reaches a low value. The use of this tube, as compared to several others, is illustrated by the curves shown in Fig. 3. With the 38, the actual possible error due to non-uniformity of relay operation is minimized.

This timing circuit has been in use for many months

and still retains its initial calibration accuracy and has also found application in many other operations (See *Electronics*, April, 1933, page 105). It makes an ideal method for operating the light source of an automatic printer in connection with photographic work. It is also very suitable for use in connection with grid stretching equipment where the time of heating the wires being stretched is very important.

Protecting meters by vacuum tubes

In using sensitive meters, such as d.c. microammeters and galvanometers, there is always the possibility of damaging the meters, due to accidental application of high voltage. Common methods of protecting meters are to have either a series resistor or fuses, or both in the circuit. However, a series resistor with a resistance value high enough to protect against maximum possible voltage would decrease the sensitivity of the meter and require a switching arrangement to short out the resistor for actual measurement. In tube-testing work the gas meter is in that portion of the circuit where if any tube elements are shorted there is applied the full plate voltage across the terminals of a microammeter.

The ideal protection for any low-range microammeter or milliammeter would be a resistor which at any current within the range of the meter being protected would have zero resistance. With any current flowing in excess of the range of the meter, this resistance should go to infinity. With such a resistor in series with any low range meter it would be impossible to damage it even with the direct high voltage applied.

A protective circuit has been developed which very closely approaches the ideal. It utilizes a vacuum tube, a resistor and a source of low voltage. When the terminals T_1 and T_2 of Fig. 4 are inserted in series with any suitable current meter, it becomes in effect a resistor having characteristics, as shown by curves in Figs. 5 and 6. That is, at low current ranges the voltage drop across it is extremely low (as is also the effective resistance). However, at any current value beyond the knee of the curve bend, the voltage drop rapidly rises. The upper end of each of the curves shown represents the condition which would exist in protective meter circuits if 250 volts were applied directly to the current meter with this circuit in series. It is this same condition that exists in factory test sets when a shorted tube is accidentally inserted in the test socket.

By suitable selection of resistor R_1 and screen-grid voltage values, it is possible to design this circuit to have a sharp cut-off at any current value desired and to correspond to the range of the meter to be protected. For instance, if a 0-300 microammeter is to be protected, R_1 should be made 12,000 ohms. Under these conditions the circuit will have a low resistance as long as not more than 300 microamps flows. However, if there should be an accidental short at X , the most current that would flow will be 460 ma., assuming a voltage of 250 at E .

This protective circuit has been in use on test equipment in this factory for over six months, and during that time not one single meter has been damaged. It is, of course, applicable to any other circuit where protection is desired for low range d.c. instruments.

Due to limited space, only the most pertinent data has been given in this article, and complete technical analysis of each circuit was purposely omitted for the same reason. Furthermore, the list of items reviewed by no means represents the entire field of use of vacuum tubes in this plant, but merely the more important ones.

Time delay effects in synchronous broadcasting

By CHARLES B. AIKEN

Bell Telephone Laboratories

IT has been very generally observed that reception is usually bad in the middle zone between two synchronized broadcasting stations, where the field strengths are of the same order of magnitude. Theoretical studies have shown that the quality of reception in such areas is dependent, to a much greater extent than has been formerly realized, upon the difference in total time of travel of the program over the two complete paths from the studio microphone to the receiving antenna. It has been shown¹ that the quality of reception will be the same as that from one station alone, provided that the two times of travel are identical, the modulations of the two carrier waves are the same, and the total low frequency phase shifts in the two paths are the same. But if the times of travel differ by only a few dozen microseconds serious distortion may result. In most cases such time differences are exceeded and reception is spoiled, but theory shows that this is not unavoidable. Relative time delay plays an important rôle, and there is given below an account of an experimental investigation of its effects.

When the waves from two stations which transmit on exactly the same frequency, and which radiate the same program, impinge upon the receiving antenna, they may

THE possibilities existent in a broadcasting system with numerous stations operating on the same frequency and with the same modulation make most important Mr. Aiken's laboratory determination of the resulting distortion at a receiving point. It is hoped that as a result of this experimental investigation a more efficient disposal of the existing channels may ultimately be made.

be regarded as combining vectorially into a single wave of complex form. In making studies of the detection of such a wave, the phase relations between analogous components of the waves from the two stations must be carefully taken into account. Assume, for the moment, that the receiving antenna is located midway between the two transmitters, so that the waves travel over paths of equal lengths in the ether. If the stations are modulated with a single frequency $\frac{P}{2\pi}$, the two waves may be represented by:

$$E [1 + M \cos Pt] \cos \omega t$$

and

$$e [1 + m \cos (Pt + \beta_0)] \cos (\omega t + \gamma_0)$$

E is the amplitude of the stronger carrier and e the amplitude of the weaker, M and m are the respective degrees of modulation, $\frac{\omega}{2\pi}$ is the frequency of both carriers, γ_0 is the phase angle between the carriers at the receiving point, β_0 is the phase angle which would exist between the envelopes of the two waves if γ_0 were zero. Now, if the receiving point is moved so that it is d_1

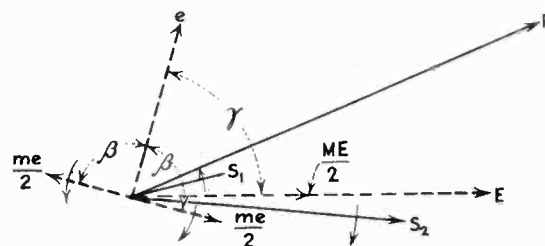

Fig. 1—Vector diagram of two waves of the same frequency and same modulation

meters from the first station and d_2 meters from the second, new values must be assigned to the phase angles in accordance with the following expressions:

$$\gamma = \gamma_0 = \frac{\omega D}{C}$$

$$\beta = \beta_0 = \frac{PD}{C}$$

where $D = d_2 - d_1$ and $C = 3 \times 10^8$ meters per second, the velocity of propagation.

The two waves impressed upon the receiver at this point may then be represented, in a very general manner, by

$$E [1 + M \cos Pt] \cos \omega t$$

and

$$e [1 + m \cos (Pt + \beta)] \cos (\omega t + \gamma).$$

The significance of γ and β may be shown graphically by a vector diagram representing two modulated waves. In Fig. 1, E represents the carrier of the stronger signal, e that of the weaker, γ the angle between them at time $t=0$; that is, when the vectors representing the two side frequencies of the stronger wave are coincident with their carrier. At this instant each side vector of the weaker wave makes an angle with its carrier which is equal to β . R is the resultant carrier and S_1 and S_2 are the resultant side frequencies. From the inequality in the sizes of these side frequencies and their lack of symmetry with respect to their carrier, it is evident that the detection of this combination of waves will yield dis-

¹A more extensive discussion of the subject matter of this paper, and of related problems, will appear elsewhere.

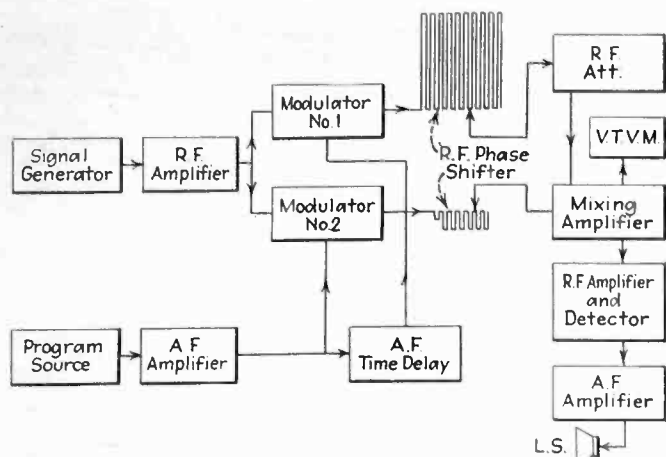

Fig. 2—Block diagram of laboratory set-up for determining effects in isochronous broadcasting

tortion products of considerable magnitude.

β is dependent upon what happens in the a-f circuits between the studio and the modulators of the transmitters, as well as upon path differences in the ether. In general, β will have a different value for each audio frequency present in the modulating program. If, for example, there is a constant difference in time of transmission of the two programs, β will be smaller for the low frequencies than for the higher. As this type of delay is of common occurrence, we may study its effect of time delay to great advantage. Furthermore, time delay due to difference in path length in the ether will affect β the same as will delay in the audio circuits.

Before proceeding to the experimental study of the effect of time delay, we shall establish an important proposition. If in (4) $M=m$ and $\beta=0$, then the sum of the two received waves reduces to:

$$E\sqrt{1 + 2K \cos \gamma + K^2} (1 + M \cos Pt) \cos(\omega t + \epsilon) \quad (5)$$

Where $K = e/E$ and ϵ is a function of γ only.

Now this is an ordinary modulated wave of amplitude $E\sqrt{1 + 2K \cos \gamma + K^2}$ and of degree of modulation M , and hence the distortion upon its rectification will be the same as that in the detection of any wave (of the same degree of modulation) which might be received from a single station. It is evident that if, in a given

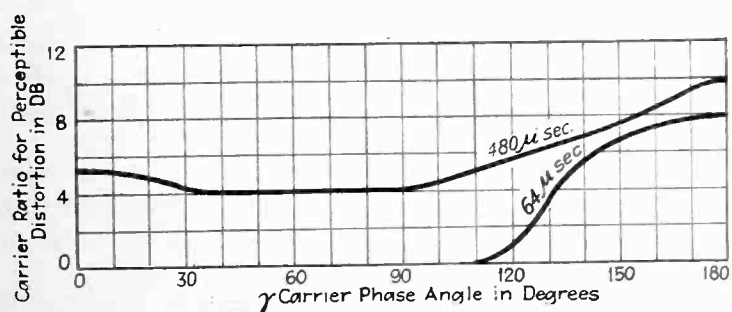

Fig. 3—Carrier ratio to cause perceptible distortion to appear in a linear detector

region, the value of β could be kept small for all of the frequencies present in the modulation spectrum, high quality reception would be possible even when the field strengths of the two received waves were nearly equal, and this would be true regardless of the phase angle between the carriers. Further, if β could be made to have a value identically zero for all of the modulating frequencies, then the quality of the rectified signal would not be impaired for any value of the field strength ratio, except insofar as noise background might appear when the resultant amplitude was very small.

Since relative time delay will have the same effect

whether it occurs in the audio or radio circuits, or the ether paths, it may be introduced at any one of these places which is most convenient. In the present work the audio circuit was chosen as being most readily manageable, and means were provided for introducing variable amounts of time delay between the program source and one of the modulators of two otherwise identical laboratory transmitters.

A block schematic of the circuits used is shown in Fig. 2. The outputs of the modulators were fed through an r-f phase adjusting device to a mixing amplifier. The phase shifter consisted of variable lengths of high frequency cable giving a phase shift of 0.80° per foot at 1100 kc., the frequency at which the work was done. A calibrated attenuator was included in one output, to adjust the relative level in steps of 0.1 db.

The mixing amplifier consisted of two shield-grid tubes having a common plate circuit impedance. Across this impedance was connected a tube voltmeter. By cutting off one voltage supply, the carrier amplifier of the other could be measured, and the process then reversed. In making measurements the carriers were first adjusted to equality at the terminals of the voltmeter. Any desired ratio could then be obtained by the attenuator.

A suitable portion of the output of the mixing amplifier could be fed to either of two radio receivers, one equipped with a square law and the other with a linear detector. Both had fidelity characteristics which were essentially flat to 5000 cycles, and both were carefully tuned to the carrier frequency. All observations were made on a frequency of 1100 kc., and the peak modulation of both transmitters was held at about 80 per cent.

Check of distortionless case

As the first observational step, a check was made on the validity of the theorem that when $M=m$ and $\beta=0$ there is no distortion but only variations in intensity of the resultant signal as K or γ are varied. To this end, the r-f output from a single modulator was divided into two parts which were fed to the two phase adjusting circuits of Fig. 2. The two signals thus derived were adjusted to equal amplitude and to various carrier phase relations. The output of the mixer amplifier was monitored on the receiver with the linear rectifier.

No difference in quality could be noted between the resultant signal and one signal alone. When phase opposition was nearly obtained, so that the resultant carrier was 44.7 db below either carrier alone, no distortion could be detected, although the background noise was unpleasant. This was due to the high noise field in the vicinity. A change in the carrier ratio of 0.1 db was sufficient to bring the resultant signal above the noise.

Determination of tolerable carrier ratio

A time delay of 480 microseconds was introduced into the program feed circuit of one modulator. There was then determined the carrier ratio at which the distortion was slightly, but definitely, perceptible. Tests were made in the open laboratory where listening conditions were about average. The distortion noted would hardly be perceptible to the average observer, although entirely appreciable to the engineer. A higher standard of quality could have been employed, but it is felt that the results obtained would have been of less value in their application to the problems of isochronous broadcasting.

The upper curve of Fig. 3 represents the average of a number of observations, and indicates the carrier ratio, as a function of γ , at which perceptible distortion sets

in when a linear detector is employed and the program consists of speech, with peak modulations running about 80 per cent. Programs were derived from two sources, a phonograph record and a high quality microphone with a 5000 cycle low pass filter in the amplifier circuit.

The character of the distortion observed near $\gamma=180$ degrees was very different from that noted when γ was near 0 degrees. With approximate phase opposition, a value of K less than that indicated by the curve resulted in non-linear distortion of an extremely unpleasant type. When $K=0$ db and $\gamma=180^\circ$ the resulting uproar was frightful. On the other hand, when γ was near zero the distortion showed chiefly as a reduction in fidelity,

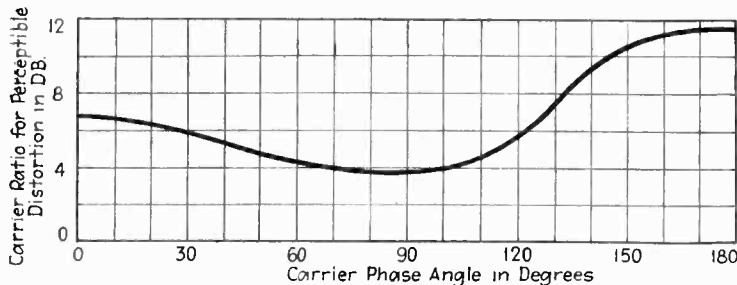

Fig. 4—Data similar to that of Fig. 3 except taken on a square-law detector

certain frequencies being badly attenuated. This was to be expected, since, with a delay of 480 microseconds, and with $K=0$ db, the frequency of 1013 cycles should vanish and the band of frequencies in the vicinity of 1031 cycles should suffer badly. However, impairment of fidelity is not nearly so unpleasant as non-linear distortion. Even when $K=0$ db the quality for γ near zero might be considered as being very nearly within the usable range, if a rather low standard of quality is assumed.

The point of perceptible distortion is much less sharply defined when the question is one of fidelity than when it is one of non-linear distortion, and the relation between the standards of judgment employed in the two cases must necessarily be rather indefinite. Consequently, the left hand portions of the upper curve of Fig. 3, and the curve of Fig. 4 (square law detector), cannot be considered as being as definitely established as are the right hand portions of these curves.

The quality of the performance of a square law detector is appreciably inferior to that of the linear detector when only a single modulated wave is received. Judgments based on a perception of additional distortions, due to the presence of a second wave, yield curves which are hardly different for the two types of rectifiers. However, the absolute magnitude of the distortion products are greater, on the average, for the quadratic type.

The lower curve of Fig. 3 is for a relative time delay of 64 microseconds. Appreciable distortion occurs only when γ is greater than 120° and the maximum carrier ratio required is less than when larger delay is used.

Figure 5 shows a curve of the carrier ratio which yields perceptible distortion when the time delay is varied, γ being maintained within $\pm 1^\circ$ of 180° . The data were taken with a linear rectifier. With a relative delay of 200 microseconds the carrier ratio necessary to eliminate distortion is practically as great as that required for larger delays.

A field strength ratio of 2:1 will permit of a relative delay of about 50 microseconds. If a larger delay occurs, there will be distortion when the carriers are near phase opposition.

The foregoing work was done with speech programs but additional work was carried out with musical programs. Observation on several types of music showed that a ratio of 11 to 12 db was necessary to reduce the distortion to a very small value. Hence a ratio that protects speech from distortion under the worst conditions will also be about right for music.

A number of interesting conclusions may be drawn from the experimental results obtained. These conclusions are in agreement with the theoretical work which has been done and from which many of them have already been predicted. They may be listed as follows:

Distortion is most serious, both in magnitude and in type, when $\gamma=180^\circ$, i.e. when the carriers are in phase opposition.

When γ is near 180° the distortion is of a very unpleasant non-linear character, while when γ is near 0° the distortion is largely a matter of impaired fidelity and is not nearly as unpleasant.

When the time delay is zero and the circuits of the two transmissions are identical to a high order (i.e., when $B=0$ for all of the frequencies present in the modulation spectrum and $M=m$) there is no distortion when a linear rectifier is used, while with a square law rectifier the distortion is the same as that which appears in the rectification of a single wave of the same modulation.

The advantage, from a standpoint of quality, which is to be gained by using a linear rectifier, instead of a square law rectifier, is about the same as that realized when only one transmission is received. The carrier

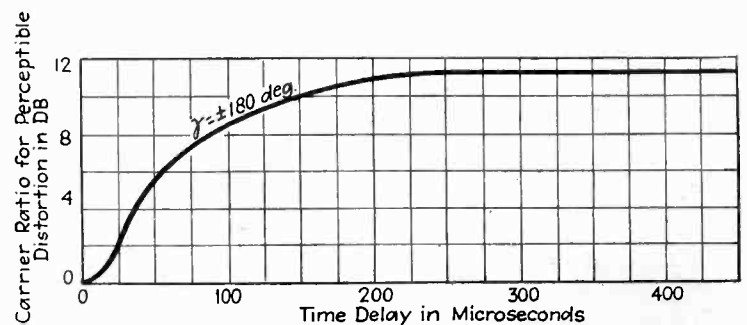

Fig. 5—Effect of time delay in producing distortion in isochronous broadcasting

ratio at which additional distortion becomes perceptible as the weaker wave is increased in amplitude is about the same for either type of detector, although the absolute quality of the output of the linear device is better.

A carrier ratio of about 12 db is sufficient to reduce distortion to a just perceptible amount, even under the worst practical conditions, provided the stations are not guilty of over-modulation.

What may be regarded as very small time delays are capable of producing serious distortion in an otherwise ideal system. This is due to a disturbance of desirable phase relations and not to anything in the nature of echo effects. Delays hundreds of times as large are required to produce the latter.

A relative time delay of 200 microseconds will be responsible for distortions which are essentially as serious as those produced by those much larger.

A relative delay of only 50 microseconds between two otherwise identical transmissions will produce a distortion, when the carriers are out of phase, which is of sufficient magnitude to require a carrier ratio of about 6 db for its elimination. Fifty microseconds corresponds to a difference in path length in the ether of only 9.3 miles.

New designs in British radio receivers

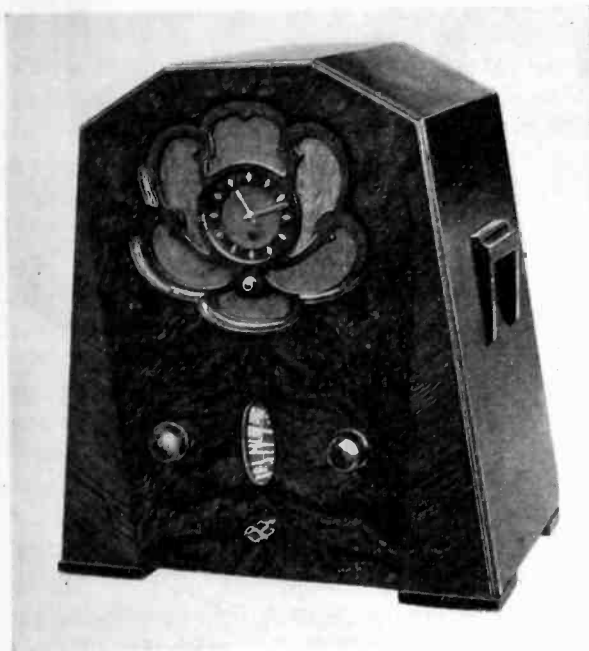

The clock-combination idea seems to interest British listeners as well as Americans. A clock is essential to listening in for special programs, and the clock is useful when the radio is turned off

British radio manufacturers have been leading the way in redesigning their receiver cabinets along radical new lines. While the designs shown are perhaps not particularly recommended for use on this side of the Atlantic, American designers who have seen these photographs declare them to be distinctly better than average American radio designs

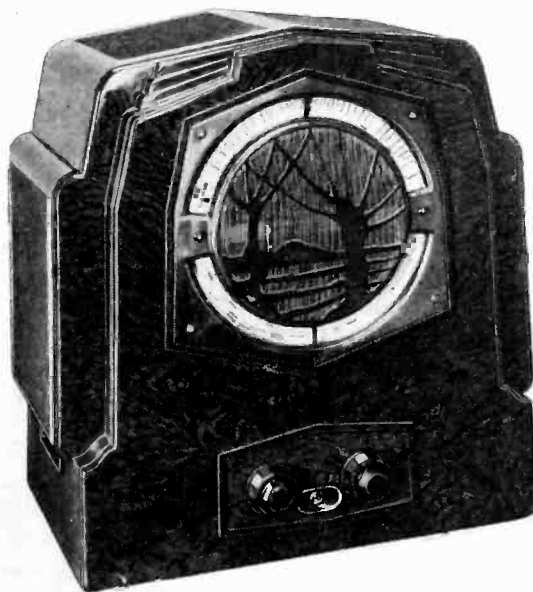

The novelty dial above surrounds the loudspeaker, and is provided with a pointer for accurate station tuning

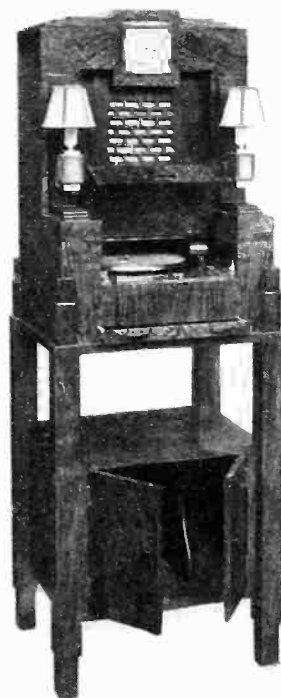

A combination phonograph-radio-clock unit

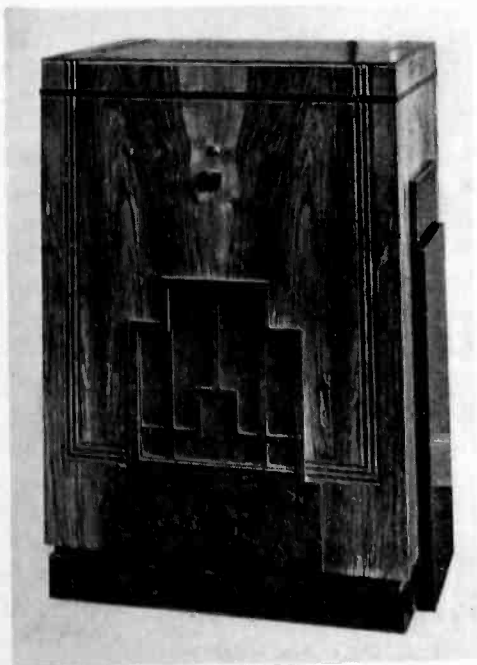

The new European art principles are apparent in these receivers occupying the lower half of the page. But already these motifs have penetrated America in other articles

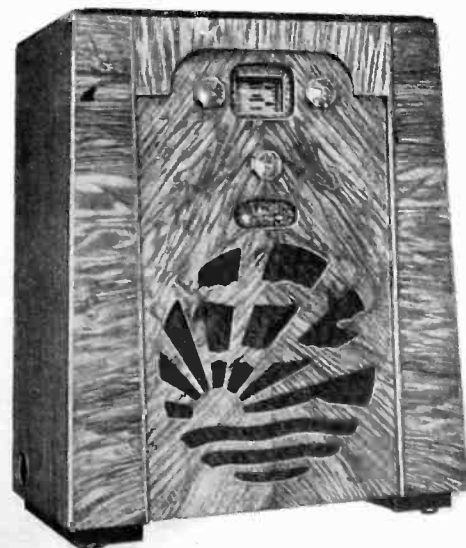
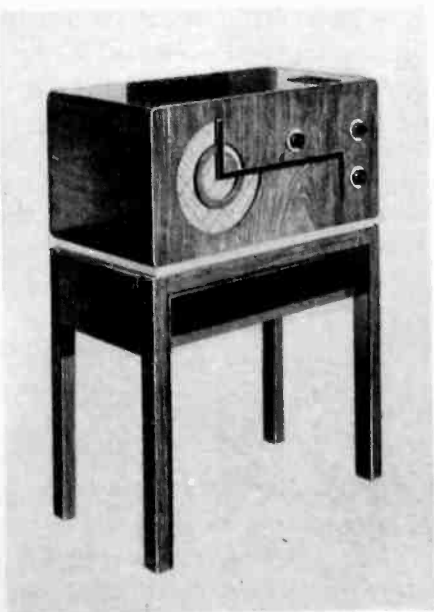

English and Continental designers go in for square and straight-line effects to a greater extent than American radio manufacturers have yet used

Photoelectric color measuring instruments

By HERBERT NEUSTADT, Jr.

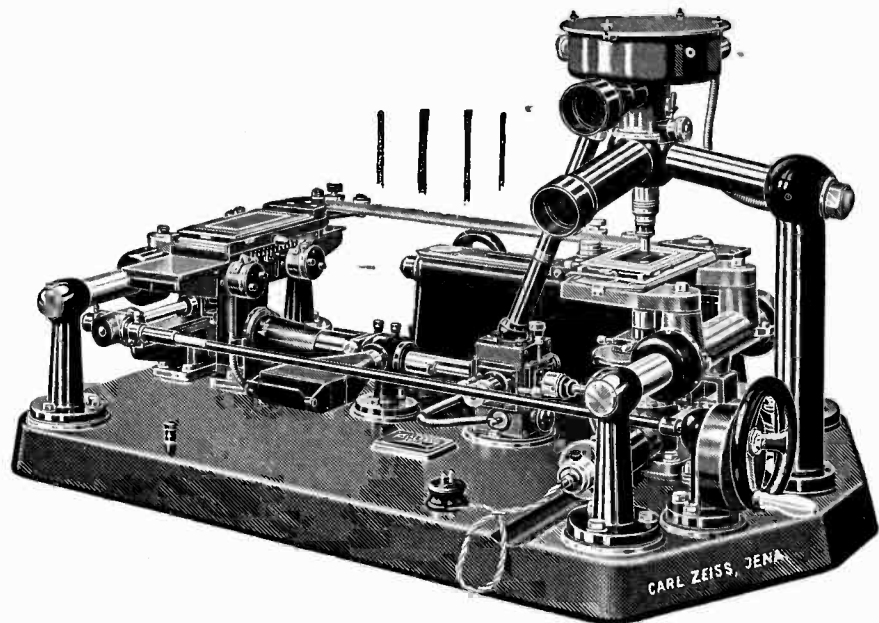

Photoelectric recording photometer of Carl Zeiss, for recording density of photographic film

PHOTOELECTRIC methods of color measurement have the advantages of: (1) speed of observations, (2) lack of eye fatigue, (3) no necessity of a trained observer, (4) full sensitivity at end regions of visible spectrum, (5) no necessity of darkening room during observations. These advantages are combined with the fact that a well designed photoelectric instrument is as accurate as any other type instrument, or more so. The instruments classified below are: color analyzers, which give a spectral energy distribution curve; color comparators, which determine whether a visual color match exists between two samples; one-variable instruments, which measure or match a single optical property of a sample.

Color analyzers

Color analyzers give complete information about the color of a sample because they produce a curve of reflection or transmission coefficients versus wavelength. These curves constitute a mathematical, unchanging definition of a color and can therefore be used to great advantage in cataloging, specifying, and mixing dyes, paints, inks, etc.

For example: the General Electric photoelectric recording color analyzer, automatically plots a continuous color curve on a liquid or solid sample for the visible range, 4000-7000 Å, in about 3½ minutes. It is accurate enough to check with Bureau of Standards data on a color filter

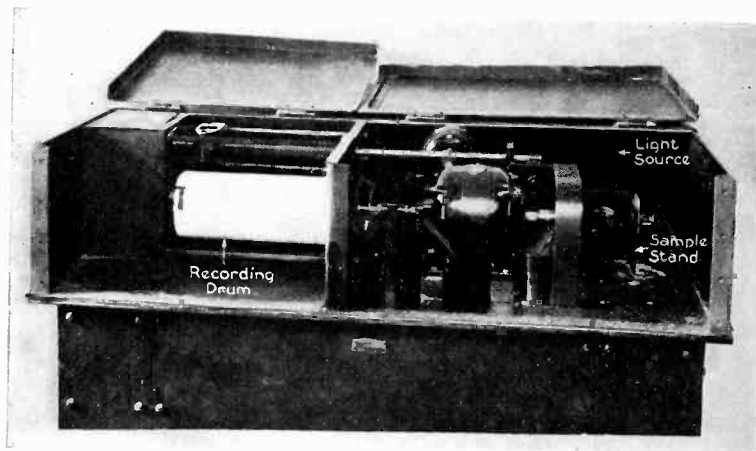

Recording color analyzer of General Electric Company

and is constant enough to retrace a curve on a sample without appreciable widening of the pen line. It represents a modification of an instrument first developed by A. C. Hardy¹ and may be described as follows. When used to obtain a reflection curve, one half of a collimated beam of monochromatic light is intercepted by a right prism and sent to the sample. The light reflected from the sample then goes to a flicker disc. The other half-beam, not intercepted by the right prism, goes to the flicker disc through a shutter. This flicker disc has its solid sectors coated with a standard white pigment and is so situated with respect to a photocell that, as it revolves, the cell alternately receives one beam reflected from the sample through the open sectors of the wheel, and then receives the other reflected from the standard white solid sectors. The alternations occur 60 times per second. If the two beams differ in intensity, the cell output will be a 60-cycle pulsating current. The a-c component of this output is applied through an amplifier to the field coils of a small motor whose armature is fed from an independent 60-cycle source. With this arrangement, when the cell receives a more intense beam from the standard than from the sample, the motor will be driven in one direction, when it receives a less intense one the motor will reverse, and when it receives equal intensities the motor will stop. By causing the motor to operate the shutter which regulates the amount of light reaching the standard white sectors, the two beams are automatically balanced. A pen records the position of the shutter on a rotating drum. The same drive that rotates the drum also varies the wavelength of the monochromatic light at a uniform rate from 4000 Å to 7000 Å. The resultant curve shows how much light reflected from the standard was equal to the amount of light reflected from the sample for every wavelength in the range. It therefore gives the reflection coefficients of the sample as percentages of those of the standard. If absolute coefficients are desired, correction factors may be applied.

The American Photoelectric Corporation has developed a spectrophotometer which is built by Eimer and Amend. There are three modifications of the instrument, one to give transmission curves in the visible spectrum, one to give reflection curves and the other to determine rela-

tive energy distribution in the ultra-violet. Each instrument essentially consists of (1) a carrier for the sample, (2) a light source, (3) a spectrometer to segregate the lines or bands of the desired wave lengths, (4) the case containing the photocell unit, electrical circuits, amplifiers, control panel, etc., (5) a galvanometer, and (6) a Wheatstone bridge, usually one of the Kohlrausch type.²

In obtaining a curve, the wavelength setting is made and then a circuit is balanced twice, first without the sample and then with the sample inserted. The desired coefficient is then read from a dial directly calibrated in absolute percentages. A curve can be drawn from a sufficient number of such readings, each reading requiring from 15 to 20 seconds.

Different types of light sources and photocells and different makes of galvanometers, bridges, and spectrometers can be used without affecting the readings more than 0.1 per cent.

Significant facts about an oil can be deduced from its color curve.³ As an example, it is shown that two peanut oils, although having different colors, have similarly shaped color curves which indicate their similar chemical constitution. Also, a peanut oil and a mustard oil that have the same value on the Lovibond scale, have unlike color curves which indicate their different structure. Since the same method can be applied to fats, waxes,

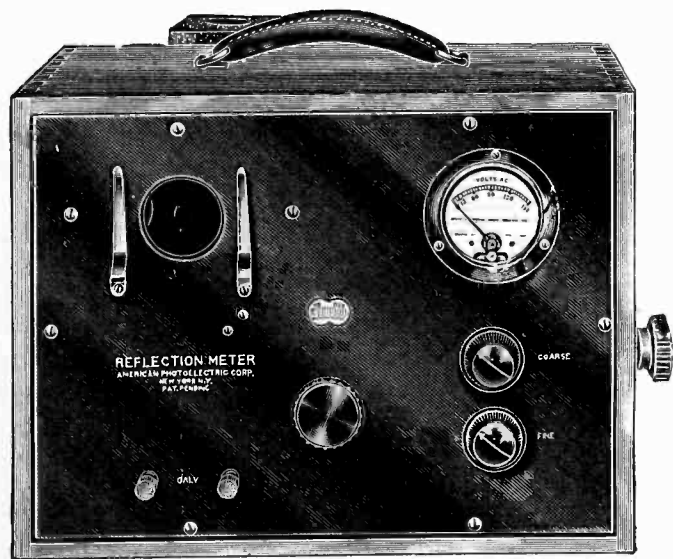

Color analyzer for transparent substances made by American Photoelectric Corporation. Range—visible spectrum

soaps, etc., and can be extended into the ultra-violet and the infra-red, it can be of great assistance to industrial and academic research.

A modification of the instrument, useful in pyrometry, will detect changes as small as one degree in the temperature of a material under heat treatment.

Color comparators

In operation, color comparators determine whether two samples reflect or transmit equal percentages of incident light. Their function, the detection of visual color matches, is accomplished by making four observations, one with white light and the other three with the three primary colors. A non-match can sometimes be detected under white light, that is the cell will not receive equal amounts of light from the two samples. But if it does, there is not yet any assurance that a good match exists. However, if the two samples reflect or transmit equal amounts of red, green, and blue light to the cell,



The Colorscope designed and built by Dr. H. H. Sheldon

they will appear to the eye to have the same color under all ordinary illuminations. In the comparators described here, tricolored filters are provided for making matches in this way. Their use is also helpful in correcting differences in color. Knowing in what portion of the spectrum the difference lies, it is possible to make an estimate of what colors should be added to one sample to make it match the other.

The Colorscope, manufactured by the Sheldon Electric Corporation of New York City, finds its widest use in the textile industry because it is especially adapted to the measurement of Fadometer and Launderometer results and to the correction of misdyes. It is a bridge, two arms of which are matched photocells. The samples are placed in holders which rotate them, and the photocells see these rotating samples by indirectly reflected light. This feature avoids error which the effect of weave, texture, or sheen might cause and allows such comparisons as wool with silk, or glossy paper with a rough sheet, on a color basis alone.

As the samples are rotated, the operator balances the bridge by varying a resistance until the galvanometer reads zero. Then the samples are interchanged in position before the photocells and rotated again. Any resultant meter deflection shows that the bridge is no longer balanced and that one sample is redder, or bluer, etc., than the other. Because the method of obtaining balance makes these deflections proportional to difference in color alone, the meter is calibrated to give percentage differences.

This feature gives the instrument certain advantages. It permits the matching of dull dark surfaces with the same precision as light ones. It also allows the operator to select some small percentage as a tolerance and use it throughout, regardless of depth of color. And the direct calibration in percentage gives quantitative information for the correction of misdyes.

Standard tiles are provided with the instrument for

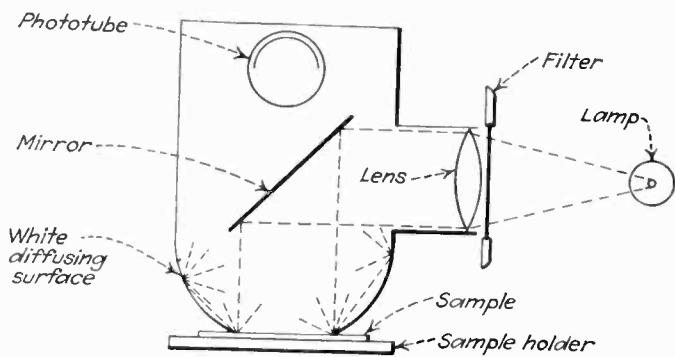

Schematic of the Westinghouse color matcher

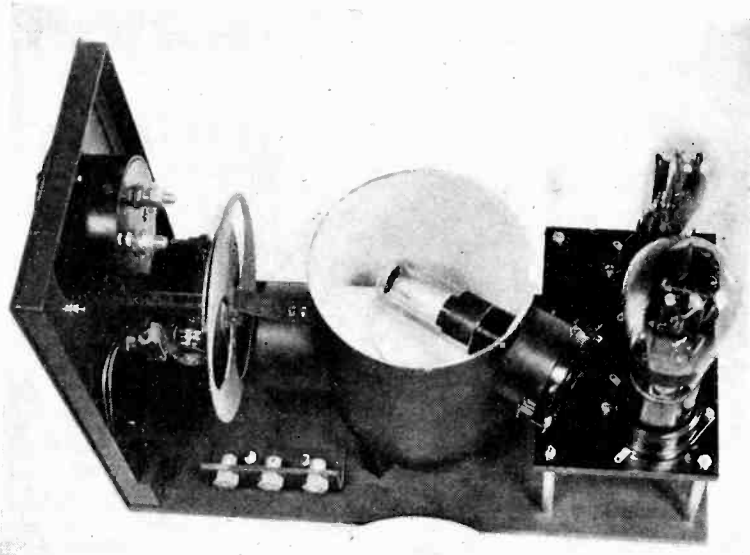

Westinghouse photoelectric color matcher

checking it each day, and a sensitivity control is used to correct any variations in the photocells.

The Westinghouse color matcher is designed to compare plates, textiles, paint samples, etc., and with minor changes, semifluids, pastes, powders, coffee, corn flakes, and so on. A sensitivity control is used to make the amplified output of a photocell bring a meter needle to midscale when the standard is in place. Then with the standard removed and the sample in place, the needle detects a match.

The electrical sensitivity is fixed; the hue sensitivity varies slightly, being more sensitive for bright materials than for dark ones. In all cases, however, the surface condition (glossy or dull) makes no difference in the color match.

The General Electric color comparator utilizes a photocell and amplifier, but in this case there is a bridge, one arm of which contains the plate circuit of the last amplifying tube. The method of use is that of balancing the bridge with the standard in place and then inserting the sample. Its accuracy is as good as that of the eye in all matches and better in the end regions. It is not calibrated because its sensitivity depends on the photocell. However, the operator can set his own tolerances for each material and check them from time to time.

A set of gray reflection standards comes with the instrument for the purpose of checking and estimating sensitivity.

American Photoelectric makes two instruments which match the total transmission of similarly colored liquids. One of these instruments, the advanced model, contains a bridge in which two arms are photocells. It can be used as a comparator or as a turbidity meter. When used as a comparator, the bridge is balanced with the standard and the sample each viewed by a photocell in the bridge. Interchanging them will then show if they match to 0.05 per cent.

As a turbidity meter, the instrument uses the Tyndall beam method and so gives values directly only when the size and concentration of suspended particles is small. But its range can be extended by interpolation between readings on similar solutions of known concentration. Readings are obtained in one or two minutes and are claimed to be more accurate than those usually obtained by evaporation. The other A.P.C. comparator contains one photocell in a bridge and matches total transmission less precisely than the advanced model.

Total reflection factors can be measured by a third A.P.C. instrument, useful in the textile and paper industries because it also measures opacity and translucency. In measuring total reflections with this instrument the standard is illuminated by a normal beam of collimated light and viewed by two photocells at thirty degrees from the surface. The output of these cells goes to a galvanometer and opposes the output of a third cell which receives light directly from the source. The galvanometer is brought to zero reading by a variable resistance and then the standard is replaced by the sample. This time the galvanometer is brought to zero by a slide wire which is calibrated to give directly the reflection factor of the sample as a percentage of that of the standard.

Measuring opacity and turbidity

Opacity is defined as the ratio of a material's reflection coefficient when backed by a non-selective black body to that when it is backed by a non-selective white body. To measure opacity with this instrument, therefore, observations are made first with the sample backed by a block of chalk, and then with it backed by a box whose inner surface is mat black. Translucency, being defined as one minus opacity, is easily derived.

The Exton Scopometer of Bausch and Lomb is a one-variable instrument designed to measure turbidities or total transmission of any liquid. It is most used in making blood tests. Referring to the figure, aperture of the diaphragm is varied by a micrometer screw until the galvanometer reads zero and the reading taken from a turncounter on the screw.

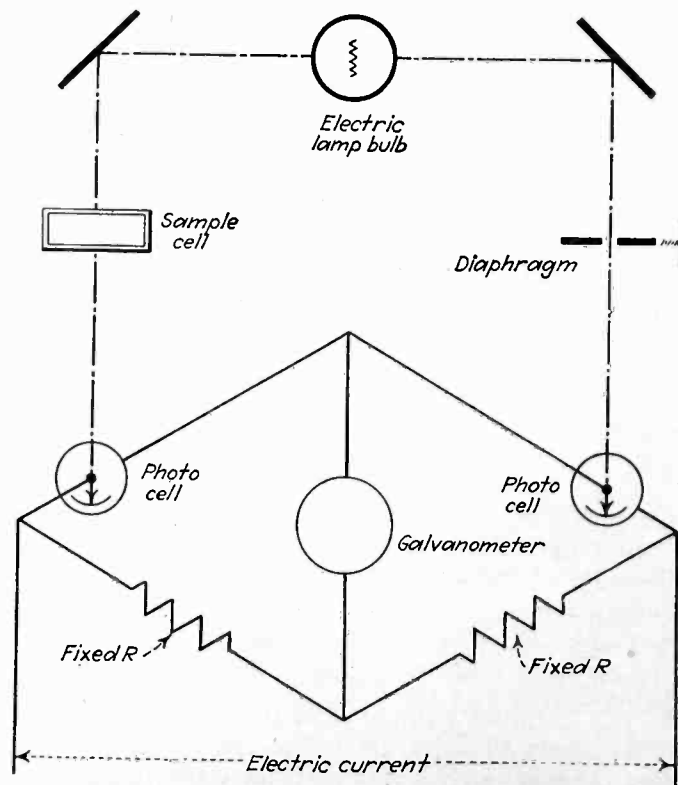
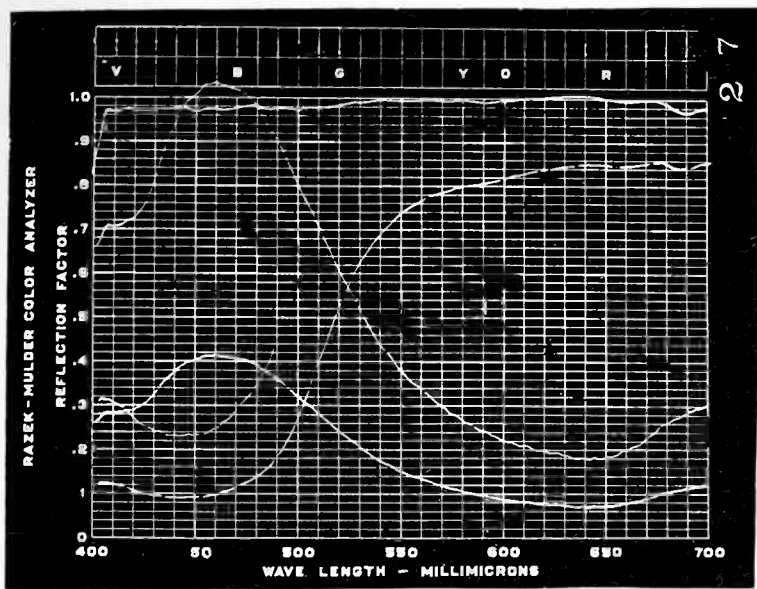

Diagram of connections of the Exton Photoelectric Scopometer sold by Bausch and Lomb



Reflection factor record (Razek-Mulder color analyzer) of a blue (left hand curves) and a yellow sample. The top curve is the standard record of magnesium carbonate

The Zeiss Recording Photometer¹ is a one-variable instrument, for obtaining intensity analyses of photographically recorded spectra. A negative on which the spectral lines have been recorded is moved at a uniform rate between a light source and a photocell. The current from this cell goes through a constant resistance and the voltage drop across this resistance is applied

to a Wulff single thread electrometer. The position of the thread is recorded on a moving photographic plate, the result being a continuous intensity curve. If it is desired to stretch this curve out to show up details, the recording plate may be made to move anywhere from 1 to 500 times as fast as the object. The instrument sensitivity is controllable by varying the illuminating lamp voltage, the curve is sharply defined even for full scale deflection, and provision is made for watching the electrometer thread during operation.

There are, of course, a great many other photoelectric instruments which measure density, brightness, etc., but because they are not closely connected with color measurements they have been considered outside the scope of this article.

REFERENCES

- ¹A. C. Hardy, "A recording photoelectric color analyzer," *Journ. Opt. Soc. Amer.* 18, 96-117 (1929).
- ²"Photoelectric spectrophotometer," *Instruments*, Feb. 1930.
- ³"Photoelectric color measurements," *Oil and Fat Indust.*, vol. 7, No. 1, 1930.
- ⁴For full description and bibliography, see *Zeiss Bulletin*, "Photoelectric recording photometer."

BIBLIOGRAPHY

- For other methods of color analysis using photocells, see: P. Mulder and J. Razek, "A portable recording and indicating color analyzer," *Journ. Opt. Soc. Amer.* 20, 155-6 (April, 1930); Cotton, 91, 981-3 (August, 1927). (Description of T. C. B. photocolormeter designed by Toussaint.); C. H. Sharp, "Various applications of the photocell with amplifier to photometry," *Journ. Opt. Soc. Amer.* 13, 304 (1926). (Description of method used at Electrical Testing Laboratories.); A. H. Taylor, "Photoelectric Spectrophotometry," *Journ. Frank. Inst.* 206, 241-2 (1928).
- For comprehensive survey and criticism of photoelectric color analyzers, see K. S. Gibson, "The use of the photocell in spectrophotometry," in, "Photo-electric Cells and Their Applications, A Discussion at a Joint Meeting of the Physical and Optical Societies June 4 & 5, 1930," published by The Physical and Optical Societies, 1 Lowther Gardens, Exhibition Road, South Kensington, London, S. W. 7.



A NEW BOOK ON ELECTRON TUBES

Theory of thermionic vacuum tubes

By E. L. Chaffee, McGraw-Hill Book Company, New York, N. Y. 639 pages. Price, \$6.

THIS BOOK WILL APPEAR as one of the electrical engineering texts issued under the editorial chairmanship of Professor Harry E. Clifford of Harvard University. This in itself would be sufficient to recommend it, but a careful examination is necessary to comprehend the enormous amount of detail required to set forth the theory of the thermionic tube with the rigorous standard which Professor Chaffee has set. The present volume deals with the physics of the tube, and its use as a rectifier and amplifier. The tube as a generator of undamped oscillations, and as a rectifier will be taken up in the second volume.

The introduction gives a short history of thermionic theory from the first observation in the seventies to the present day status. This is followed by chapters on the structure of matter and conduction through gases. Two chapters deal with Thermionic Emission and Practical Sources of Emission. Professor Chaffee presents in an impartial manner with complete tables and curves the controversial data regarding the constants

in the emission equation. The results on oxide-coated filaments are summarized with a theory which leans toward the point of view that a monatomic film of the active metal does the emitting, and is continually renewed by electrolytic conduction from below.

The letter symbols and nomenclature used thereafter in the book are followed by a treatment of the static characteristics of the triode in dependence on its structural parameters.

The dynamic measurement of the triode coefficients is thoroughly discussed, methods of balancing out the tube capacities being given. Effects of gas in a tube are taken up, and a set of complex coefficients for a soft tube developed. In view of the work on positive ion tubes reported on by Dr. Hund last year, it would appear that this material will have some application in the immediate future.

A rigorous derivation of the input admittance of a tube, resulting in a "generalized equivalent plate circuit theorem" precedes a general discussion of the gains in different types of single stage amplifiers. A valuable section, of direct value to the receiver designer, treats the relative merits of different types of amplifiers for equal band width.

Regeneration in a triode is followed by an extension to the case of coupled circuits. In spite of the present day

tendency away from regeneration, its inevitable presence on account of small coupling effects makes a rigorous treatment valuable.

A chapter each is devoted to resistance, impedance, and transformer-coupled amplifiers, the theoretical treatment being followed by descriptions of experimental set-ups for verification of the results developed by the analysis.

Treatment of small-signal detection precedes a description of laboratory methods for measuring the "detection coefficients." The relative merits of grid and plate detection are clearly brought out.

In the study of large signal detection, Professor Chaffee develops a new graphical method which has the merit of absolute rigor. Applications are made to the distortion errors produced in vacuum tube voltmeters. The "variable- μ tube" is discussed, and the question of low grid current tubes for amplification of minute voltages touched on.

In unqualifiedly recommending this book to the engineering profession, there is no need to indulge in superlatives. The book is complete and authoritative. It brings under one head a tremendous amount of material hitherto unpublished or scattered throughout the technical literature.

W. J. CAHILL.

HIGH LIGHTS ON ELECTRONIC

Photocell controls truck-garage doors

THESE DOORS OF THE TRUCK garage of the Westchester Lighting Company, Mount Vernon, N. Y., are 14 ft. high and are of the steel-curtain type which roll up. They are motor driven. "Open" and "Close" buttons at the side of the doorway furnish manual control. There are two buildings housing Westchester Lighting Company service trucks, each with a door of this type and each has been equipped with photoelectric control.

The buildings are heated by unit heaters. A great deal of heat was wasted formerly by truck drivers leaving the doors open, and the inconvenience of getting out of a large truck to open the doors and again to close them has been eliminated.

It was decided to place a photoelectric control on each of the exit doors as an experiment. This has been done and has been in successful operation for several months.

The following are features of this installation:

1. The doors open at the approach of a truck.

2. The doors are prevented from closing until the truck has cleared the opening.

3. The doors will stop if a person walks through the opening while the door is coming down.

4. A "stop" and "go" light inside (left of door) tells driver when to go and warns him to stop if the door is not fully raised or is coming down.

5. Another "stop" and "go" light actuated by the door regulates traffic outside the buildings in the yard.

6. Light rays are so arranged as to permit free movement of trucks and persons inside the garage without causing false operation of the doors.

One light projector is in a concrete pit in the floor and shines upward through a hole in a manhole cover to a phototube in a box over the doorway. When blocked, this ray opens the door.

The other projector shines a beam of light horizontally across the doorway,

close to it. It is this ray that acts as a safety guard, preventing the closing of the door, even manually, until the truck has cleared the doorway. Blocking this ray will stop the door if it is coming down.

Another interesting feature of this installation is the fact that the limit switch actuating the "stop" and "go" lights also turns on a motor-operated valve which cuts off the steam supply to the unit heaters when the door is open. With cold air blowing on the garage attendants instead of hot, it is not likely that the doors will be left open very long—another reason for the continued use of the photoelectric control which will automatically keep the doors closed at all times. Everything is water-proof as floor is washed with high-pressure hose.

Locating fish by submarine echoes

AT A RECENT MEETING of the New York Electrical Society, Dr. Herbert Grove Dorsey, U. S. Coast and Geodetic Survey, told how his invention, the fathometer, is being used by fishermen to locate depths at which certain types of fish congregate, thus greatly increasing the day's catch when the fishing fleet is properly located. Dr. E. E. Free, past-president of the Society, now reports a similar method employing submarine echoes to be used by the British Marconi Company.

A sound signal is created electrically on the ship, sent through the water to the sea bottom and its echo picked up as it returns to the surface. Knowing the time occupied by this echo and the speed of sound in sea water, it is possible to calculate how deep the water is at that spot. Users of this device are said to have noticed, in addition, that the character of the echo depends on the nature of the sea bottom. A bottom of soft mud gives an echo different from that of a bottom of sand or of jagged rocks. Soon it is expected to be possible to reduce these bottom indications to simple enough rules so that ships' captains can use the echo sounding device to learn the nature of the bottom underneath them as well as its depth. Similar modifications of the character of the bottom echo are observed when there are schools of fish part way down in the sea and it is expected that these indications, too, can be reduced to rules permitting fishing fleets to tell just where the sea underneath them is populous enough to make it profitable to let down the nets.

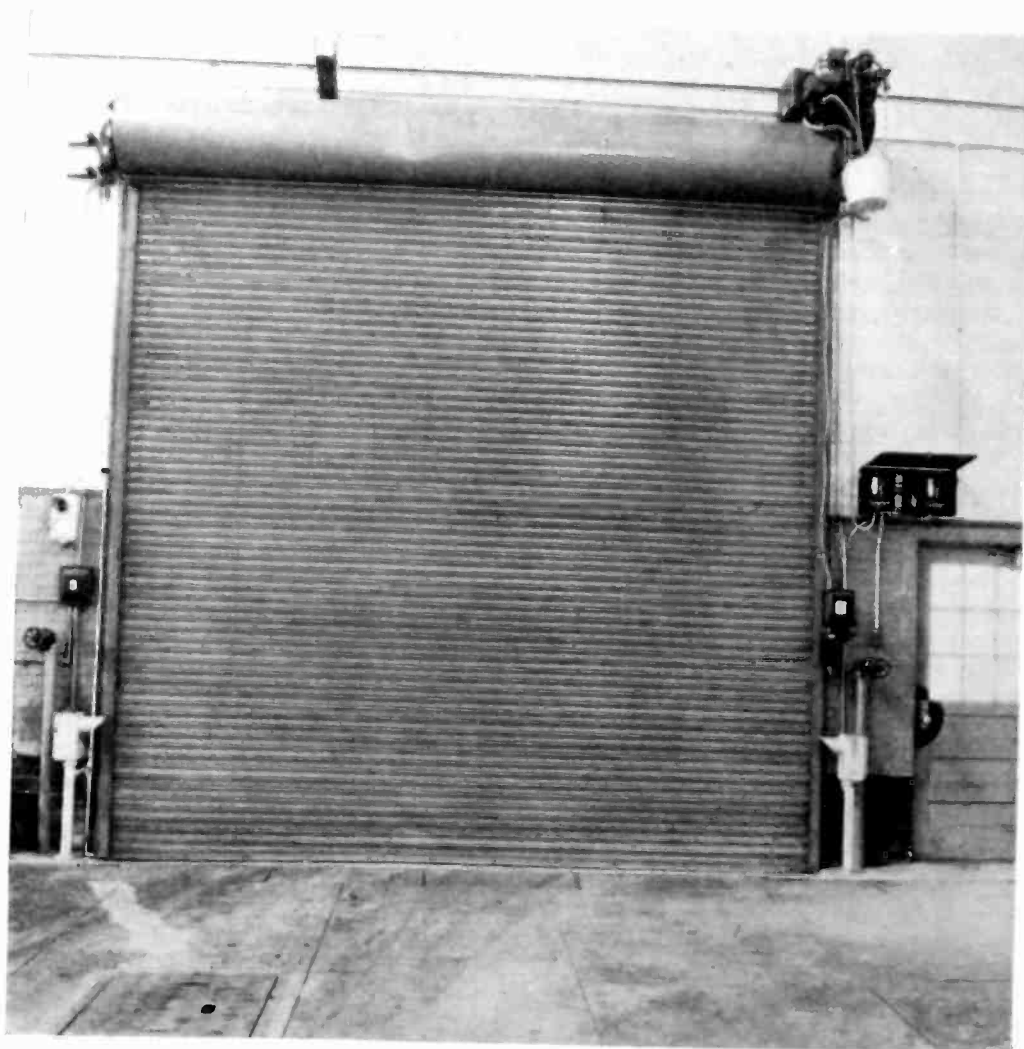

Light-projector pit is in the left foreground with manhole cover with hole in it for light to shine through. "Stop" and "go" lights are at the left part way up. Control panel containing two photoelectric and several auxiliary relays at the right over small doorway. Toggle switch below for disconnecting the photoelectric control

DEVICES IN INDUSTRY + +

15 miles of electron tubes to light World's Fair

MOST MODERN OF LIGHT SOURCES, gaseous discharge tubes will be called upon to do their spectacular best at the World's Fair Century of Progress Exposition in Chicago. According to recent estimates, when the exposition opens formally in June it is probable that between 75,000 and 100,000 ft. of gaseous discharge lighting will be in use on the grounds.

Among the more interesting developments is the recently announced cascade of green and blue light produced by 1½ miles of gaseous tubes on the windowless walls of the electrical building. This waterfall effect will be horseshoe-shaped, following the contour of the electrical building. Seven banks of green and blue colored gaseous tubes will rise 55 ft. vertically at intervals along the walls. Spray and steam rising from pools at the bottom of the walls will heighten the cascade effect.

A total of 7,500 ft. of gaseous tubes will be used for this illumination spectacle—the largest amount ever utilized for lighting the exterior of a single building. The tubes will be exposed and produce direct light, instead of being concealed, as is the case with gaseous lighting effects elsewhere on the exposition grounds. There will be no obvious supports for the tubes, thus increasing the mysterious effect their light will produce.

In addition to the exterior lighting, extensive use of gaseous tubes is made in interior lighting in the electrical building. In the great semi-circular hall in which exhibits will be presented by leading electrical companies, manufacturers of electrical equipment and utility companies 1,250 ft. of red-colored tubing and 1,200 ft. of gold-colored tubing is being installed.

+

New advertising possibilities with electron tubes

"THE TECHNOLOGY WHICH produced radio broadcasting, seems destined to revolutionize advertising methods still further, both by providing wholly new electronic media now as little known as broadcasting once was, and by radically revising present printing methods," declared Orestes H. Caldwell, president of the New York Electrical Society and editor of *Electronics*, speaking before the Advertising Club of New York City, on the subject "New Things Up Radio's Sleeve for Advertising Men."

"Next year's radio sets may deliver

you your morning paper when you come down to breakfast. By switching off the loudspeaker at bedtime, you would start a radio facsimile recorder which would receive and print your paper, headlines, cartoons, and all. Such facsimile newspapers are now being transmitted to ships in mid-Atlantic; plans for similarly hooking up home radios are complete, waiting only a good time for launching," said Mr. Caldwell.

"Talking books and talking newspapers will serve another class. Such talking books comprise short loops of film or paper, and will reproduce at any length. Such talking newspapers would also have the advantage of being brightened with songs and music.

"The electric-light wires are now being used in Cleveland to bring music and news by wired wireless—free of fading, static and distortion. Electric signs on country roads flash on when an approaching car's headlights come into view.

"In some fifteen different ways electric eyes are now revolutionizing the familiar processes of printer's ink," continued Mr. Caldwell. "Already linotypes set type directly from the reporters typewritten copy, without the presence of any operator. By photo-electric scanning, halftones are made directly from photographs in the time it takes the editor to write the caption. Simultaneously identical halftones might be produced in 40 cities. Color plates can be

produced in half an hour, at a fiftieth the present cost. Electric eyes insure register in color printing; measure capacity; count sheets pouring through the bindery; and stop the presses in case of a paper break.

"Meanwhile radio broadcasting advances from a merely national scale, to a point of world coverage, so that an advertising message broadcast on short waves from a New York studio, may confidently be known to be picked up in Europe, South America, Africa and the Orient."

+

U. S. Navy's cathode-ray storm indicator

THE NAVAL RESEARCH LABORATORY, near Washington, has been working on a development of Watson Watt's method for determining the direction of static. The equipment consists of two loops at right angles. The four terminals of the loop are connected through a receiver to four plates of a cathode-ray tube fitted with an azimuth circle. Incoming signals produce a straight line on the face of the cathode-ray tube and the direction of the incoming signal is read from the azimuth circle. The equipment is resonant at about 13 kcs., according to Commander W. J. Ruble, assistant director of the Laboratory.

+ + +

RADIO TOWERS OF CREOSOTED PINE

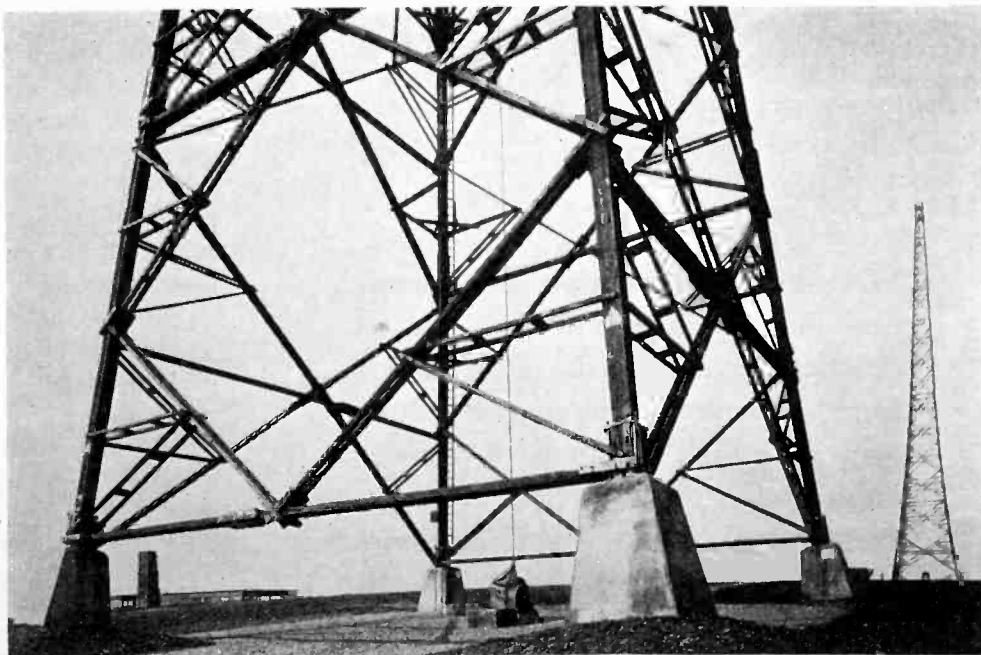

The Muhlacker radio station at Stuttgart, Germany, employs these 330-ft. towers built of creosoted Southern pine. Similar towers have been built to heights of 525 ft., according to Axel H. Oxholm, director of wood utilization, Department of Commerce, Washington

Bridge-type push-pull amplifiers

By LEONARD TULAUSKAS

IN THE compact radio receiver of today, the various components are crowded so greatly that coupling of greater or lesser degree exists between all parts on the chassis. This does not present very great difficulties in the design of the radio frequency portion of the receiver but on account of the large field around the power transformer and filter choke (the field around the choke is particularly strong when choke input is used as with the 83-type tube) the amount of hum voltage induced in the audio frequency wiring is considerable and in most cases can be eliminated only by careful routing of the wires. While this represents a satisfactory solution for the amplifier terminating in a single output tube through a resistance-capacity coupled detector, it is of little avail where a transformer coupled push-pull output stage is used. In the latter case, the size of the input transformer is so great, relatively, that the hum pickup is mainly determined by the voltage induced in this transformer from stray fields instead of by the rest of the audio frequency wiring. It might also be pointed out that in general it will be impossible to mount the input transformer in such a position that cancellation of hum occurs unless the fields of the power transformer and filter choke are symmetrical with each other and are so far removed from

▼

FOR many years the omnipresent push-pull amplifier circuit remained practically unchanged. Its freedom from harmonics and hum, and its comparatively high output have made it indispensable to the modern radio set. Present day space—and cost—requirements, however, have brought interesting and useful modifications of the original circuit into popular receivers.

▲

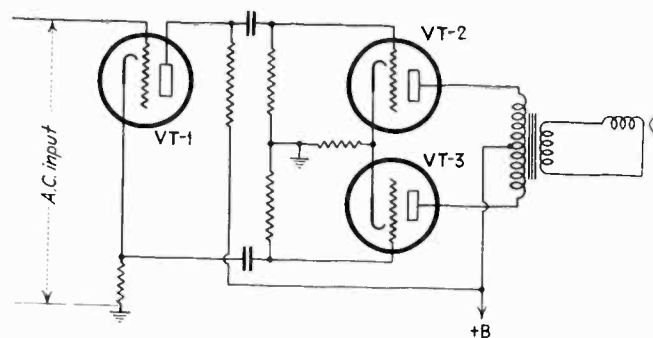

Fig. 1—Method of driving push-pull stages from a single tube by resistance coupling

each other that the audio-frequency transformer is subjected to the field of one alone.

This problem was overcome by one radio manufacturer by using output pentodes in parallel instead of push-pull, thus making possible resistance coupling instead of transformer coupling to that stage. A suitable pad consisting of the tone control resistance and a condenser in series with it was shunted across the primary of the output transformer to prevent the load impedance from rising too high at the upper audio frequencies. At 6 watts output this amplifier produced only 10 per cent total harmonic distortion compared to about 9 per cent for a similar push-pull arrangement. In order to compensate for the reduced low frequency response caused by the large

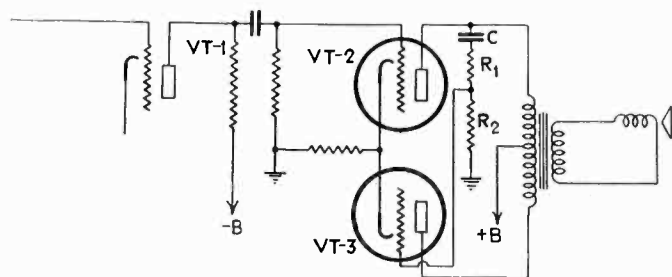

Fig. 2—Circuit in which the second of two push-pull tubes gets its excitation from the first tube output

direct current flowing through the primary of the output transformer, however, some low frequency regeneration was introduced so the over-all response was very satisfactory.

While the arrangement described above was used to eliminate hum and for no other reason, it would prove quite expensive in comparison to the cost of some other schemes to be described. These circuits are all of the push-pull type primarily because of the even harmonic cancellation which occurs in the output circuit and which make an impedance adjusting pad unnecessary.

A highly satisfactory scheme is shown in Fig. 1. The voltage developed across the cathode series resistor is practically 180° out of phase with the voltage across the plate load resistor. By suitably proportioning the two resistors, voltages equal in magnitude, but 180° out of phase will be delivered to the grids of the push-pull tubes. Although *Vt-1* is shown as a triode in the diagram, a tetrode or pentode may be used with even greater advantage. Likewise, the output tubes may be triodes or pentodes working as class A amplifiers. This type of circuit has found considerable favor in Europe and has also found some application in sound recording amplifiers for motion pictures. It might be well to point out at this point that in general the heater of *Vt-1* must be connected to a separate winding on the power transformer.

In the above circuit, the voltage applied to the grid of

each push-pull tube was only one-half of the total voltage developed by the phase splitting tube. This means that the total audio frequency gain is reduced by one-half, which may be insufficient amplification for some purposes. The circuit shown in Fig. 2 impresses the entire voltage developed by the driver tube on the grids of the push-pull tubes. A simplified explanation of the action of the circuit is as follows: C is quite large in value so that it offers a low reactance to the audio spectrum. R_1 and R_2 act as a voltage divider across the upper half of the output transformer which presents a resistive load to the tube (except at speaker resonance). Consequently, the voltage developed by $Vt-2$ across this load is divided in the ratio of the two resistors; a definite portion is impressed on the grid of $Vt-3$. This voltage is 180° out of phase with the input voltage to $Vt-2$ by virtue of the phase shift occurring in that tube. True push-pull action will occur when the voltage on the grid of $Vt-3$ is equal in magnitude and opposite in phase to that on the grid of $Vt-2$. If R_1 and R_2 are large compared to the reflected load resistance, then the voltage developed across the output impedance of $Vt-2$ can be closely represented by the following equation:

$$E_2 = \mu_1 E_g \frac{R_p}{R_p + r_p}$$

where

- E_2 = a.c. voltage developed across load resistance.
- μ_1 = amplification factor of $Vt-2$.
- R_p = reflected load resistance.
- r_p = plate resistance of $Vt-2$.
- E_g = a.c. voltage impressed on grid of $Vt-2$.

It is desired that the voltage across the grid of $Vt-2$ be equal in magnitude to E_g as it was previously shown that it will be in opposite phase. Therefore

$$\frac{R_2}{R_1 + R_2} \mu_1 E_g \frac{R_p}{R_p + r_p} = E_g$$

Cancelling,

$$\frac{R_p}{R_p + r_p} = \frac{R_1 + R_2}{R_2}$$

This equation is important for several reasons. First, it indicates the correct proportioning of the various resistors to secure equal grid voltages. Second, it shows that this equality is preserved regardless of the grid excitation. Third, if the voltage across the load resistance is given as $i_p R_p + j i_p \omega L$, it will be found that ω drops out indicating that the voltage division is independent of frequency. This seems to be an ideal way in which to obtain a single-ended push-pull amplifier but some experimental work showed immediately that considerable difficulty could be expected.

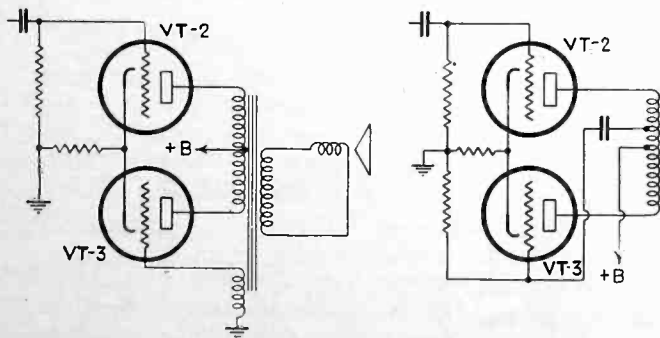

Fig. 3 Left—An experimental method of connecting push-pull tubes

Fig. 4 Right—Final method of exciting second of two push-pull tubes

Referring again to Fig. 2, it will be noted that $Vt-3$ is connected in the circuit in much the same fashion as a Hartley oscillator. Consequently, it will oscillate at one of two possible frequencies; that determined by the leakage inductance and stray capacity of the circuit or the natural period of the loud speaker. The high frequency oscillation can be readily eliminated by shunting a pad consisting of a condenser and resistor in series across the primary of the output transformer. The low frequency oscillation is extremely difficult to subdue; when eliminated, the power output is greatly reduced. It is also possible to use two condensers in series as the voltage divider instead of R_1 and R_2 . This reduces the tendency for high frequency oscillation but seems to aggravate the condition at resonance.

Another scheme is shown in Fig. 3. This arrangement was quite satisfactory except that the amplification was low at the higher audio frequencies. This condition was remedied by using an output transformer in which the tertiary winding was interspersed throughout the primary by means of pies. However, the cost of such a transformer was too high for use in production receivers.

The final arrangement adopted is shown in Fig. 4. This is very much the same as the above except a tap is utilized on the primary as a step down auto-transformer

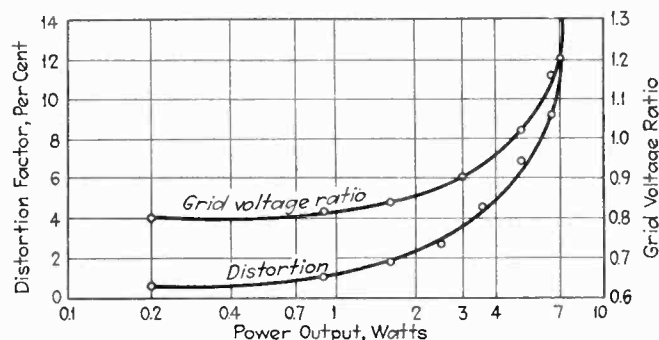

Fig. 5—Output characteristics of bridge-type amplifier using push-pull 47 tubes

instead of making use of the separate winding. As expected, the fidelity of this arrangement closely approached that of the final model shown in Fig. 3. The criterion of performance of such an arrangement can best be judged by a consideration of the power output vs. per cent distortion curve. Fig. 5 shows such a curve for this amplifier with 47's in push-pull in the output stage. It is significant that from 6-7 per cent distortion at 2.5 watts output is obtained from a single 47 tube, while the curve shows this push-pull arrangement exhibits only 2.5 per cent distortion at the same output.

The ratio of the a-c grid voltage on the driver to that on the driven tube is shown in Fig. 5 also. Note the corresponding rise in distortion as the grid voltage ratio changes. While the theoretical consideration of this circuit indicated a constant grid voltage ratio, actually, the change in plate resistance of the tubes at extremely large grid swings is great enough to upset the balanced condition existing under normal loads. At reasonable output levels, the balanced condition holds very well and for this reason this circuit is known as a bridge type push-pull amplifier.

In conclusion, the writer wishes to express his thanks for the original details of this circuit to Mr. W. W. Dunn of the Grigsby-Grunow Company and to acknowledge the efforts of Mr. Leidy of the Chicago Transformer Company to produce the experimental and final transformers for the amplifiers.

A shorted-turn indicator

By C. G. SERIGHT

NEITHER AN INDUCTANCE NOR a d.-c. resistance test will reliably evidence a single shorted turn unless the winding consists of relatively few turns. The best way to test for shorted turns is to couple the coil inductively to an a.-c. circuit, and measure the power drawn from that circuit. A good coil will absorb negligible power; one containing an internal short will absorb energy at a rate depending on the number of turns shorted, the tightness of the coupling, the frequency of the induced emf., and the impedance of the shorted section.

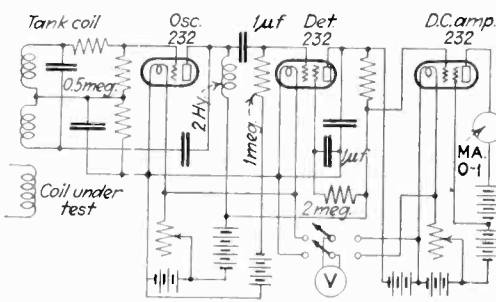

The rate of absorption increases with frequency, but the frequency must be low enough that no appreciable current flows through the distributed capacity of the tested coil, as such capacity currents cause spurious absorption in good coils.

For large coils, such as transformer and filter-choke windings, suitable apparatus consists of an "E" shaped iron core carrying windings connected in a "balanced" circuit, an amplifier, and an uncalibrated vacuum tube voltmeter. The tested coil is slipped over an outer leg of the core, and if it contains shorted turns, the coupling circuit is unbalanced, and the unbalance indicated by the V. T. voltmeter. The central leg of the core is excited with a.-c. from the power mains.

Other types of coils, such as those wound on integral spools, and loud-speaker voice-coils with centering spiders, cannot be tested on an iron core coupling device. For such coils, the writer constructed a shorted turn finder of different design.

Since a test frequency many times higher than 60 cycles was permissible for these small coils, a vacuum tube oscillator was used as the a.-c. source. The operating principle is that an oscillator's tank circuit voltage will vary in accordance with the rate of absorption of energy from the tank circuit. The tested coil was coupled to the tank inductance, which was coupled to a detector, the detector in turn actuating a d.-c. amplifier having the indicating milliammeter in its plate circuit. Any absorption by the tested coil resulted in

reduced detector input, and a consequent reduced reading of the indicating meter.

A type 230 tube was used as the oscillator. A resistance network in its grid circuit prevented high damping of the tank circuit oscillations during positive grid voltage excursions, reduced the input voltages to the tube, thereby curtailing harmonics. Large harmonics were to be avoided because of their greater tendency to set up spurious absorption currents in a tested coil. The oscillator was tuned to approximately 8,000 c.p.s., the highest permissible frequency for the largest (electrically) type coil to be tested.

The tank inductance used consisted of 950 turns of No. 20 enameled wire, compactly wound in solid layers, with thin paper between layers. The winding cross-section was approximately 1½ in. square. The window of the winding was just slightly larger than the largest diameter coil to be tested. The tank coil was housed in a protective bakelite shell; and mounted on a tilt of 45 degrees near the bottom of the test panel, directly under the indicating meter.

One-half the tank circuit a.-c. voltage was impressed upon the detector which was supplied a compensating negative bias of 45 volts through 1 megohm. Thus, small variations in peak input voltage were thrown upon the straight part of the E_g-I_p curve, giving maximum detecting efficiency.

The d.-c. amplifier was operated by separate batteries, the only connection to the remainder of the circuit being the 0.5 meg. resistor common to the detector plate and the amplifier grid circuits. Since this resistor put a positive bias on the amplifier grid, a counteracting bias battery of 22½ volts was included in the grid circuit to keep the amplifier plate current below 1 ma. The normal plate current was thus set at approximately 0.8 ma. a downward swing indicating shorted turns.

The only adjustment necessary, preparatory to testing, was setting the filament voltage. To test a coil, it was simply inserted into the window of the tank coil. A large reduction in the reading of the milliammeter indicated shorted turns, good coils giving practically unchanged deflection. One closed turn one-half inch in diameter of No. 35 wire would reduce the indicating meter deflection 0.6 ma. This was the smallest turn of the finest wire in any coil to be tested, representing therefore the smallest absorption to be indicated. (An equivalent shunt leakage in the insulation of an entire winding would, of course, produce a similar reading.) On the other hand, the largest coil (electrically) to be tested showed a change in deflection due to distributed capacity effects of less than 0.1 ma.

Square-top filters

BAND-PASS FILTERS AS used with straight t-r-f sets have the disadvantage that the width of the band does not remain constant over a wide range of frequencies. In the case of superhets the filter can be placed ahead of the i-f amplifier and rendered more effective as it has to deal with one frequency only.

When (Fig. 1), taken from an article in *Hochfrequenz und Electro Akustik*, 41:23-26, 1933, by H. Piesch, the grid of the first i-f amplifier tube is shunted by a parallel resonant circuit (L, R in parallel with C), a small condenser Δc in series with the resonant circuit, the voltage will build up to a maximum at the resonance frequency of the parallel circuit $f_o = 1/6.28 \sqrt{LC}$, while the resistance will drop to near the short circuit condition near the frequency $f_1 = 1/6.28 \sqrt{L(C + \Delta c)}$. By taking Δc fairly small in comparison with C , a steep cut-off may be obtained somewhere between these two frequencies.

If, moreover, a parallel resonant circuit (L, R in parallel with $(C - \Delta c)$), and, in series with it, a second small condenser Δc , are inserted in one of the leads before it comes to the grid of the amplifier tube, there will be a con-

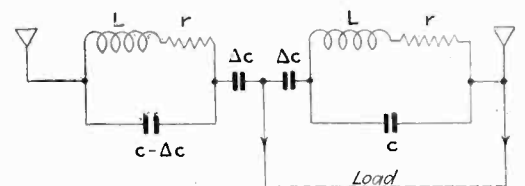

Fig. 1

siderable voltage drop in this lead at the resonance frequency, $f_2 = 1/6.28 \sqrt{L(C - \Delta c)}$, and a relatively small drop for the frequency $1/6.28 \sqrt{LC}$ with a steep fall in voltage on going from one frequency to the other. The amplification can be limited to a nine or ten kc. band by suitably choosing the circuit constants (Fig. 2).

The device is not only a band-pass filter, it also acts as an amplifier. Let e be the voltage input to this filter circuit, and E its output voltage. When resistance of coils and condensers need not be considered,

$$\frac{E}{e} = \frac{[1 - p^2 LC (1 - s)] [1 - p^2 LC (1 + s)]}{[1 - p^2 LC (1 - s)] [1 - p^2 LC (1 + s)] + (1 - p^2 LC)^2}$$

where $p = 2 \pi f$ and $s = \Delta c / C$. The value of this fraction is equal to unity for $1/6.28 \sqrt{LC}$, but soars to high values for the limiting frequencies f_1 and f_2 . Within this band, on both sides of f_o , the fraction is somewhat larger than unity with a peak at two frequencies which depend on the ratio s .

FROM THE LABORATORY ★★

With $s = 0.15$, and $f_0 = 75$ kc. as the i-f, these two enhanced frequencies are 79 and 71 kc., that is, they are close to the complete cut-off.

When the resistance of the coil is taken into consideration, the top of the band becomes flattened and the cut-off less complete. It is also important that

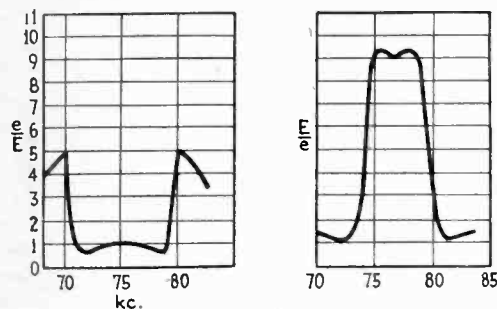

Fig. 2

the capacity of the load into which the band-pass filter delivers energy be kept as small as possible, not more than a few μf . If in the above example, the load represents a capacity of $0.015 C$ or $0.15 \Delta c$, the frequencies for which the amplification reaches its highest value lie near 77.25 and 72.4 kc. and much of the square-top effect is lost. Loose coupling of amplifier and filter is an advantage in this respect.

Measurements with the aid of a vacuum-tube voltmeter, on a band-pass filter having a resonance frequency of 77 kc. and a band-width of 5 kc. show the steep cut-off despite the fairly high input capacity of the voltmeter (Fig. 2). The amplification at resonance is lower than near the cut-off frequencies, but this defect serves to square off the top of the band if, as is usual in European superhet sets of simple design, an r-f amplifier follows the antenna.

On the other hand, by throwing the shunt out of tune, the amplification may be made to fall with the frequency so as to obtain a compensation with regard to the a-f stages.

Radiation by antennas without and within reflections

THROUGH THE COURTESY OF the Goodyear-Zeppelin Corporation a small non-rigid dirigible was available for measuring the field distribution around a vertical half-wave antenna, operated at a frequency of 29 megacycles per second (10.345 m.) and suspended one-eighth of a wave-length over water. The results at distances greater than 50 wave-lengths are in good agreement with Sommerfeld's formula, below this distance Strutt's approximation holds except near the surface of the water. (The latter formula gives a dead zone at any altitude over points about 50

wave-lengths from the antenna.) These measurements are reported in *Publications from the M.I.T., Serial 85, 1933*, reprinted from *Proc. I.R.E.*, by J. A. Stratton and A. H. Chinn, Mass. Inst. Techn.

G. J. Elias and C. G. Van Lindern, of the Inst. Techn., Delit. report in *El. Nachr. Techn.* 10:1-8, 1933, work on 54-m. and 81-m. waves which were received on vertical half-wave aerials or frames and sent from horizontal antennas. These waves are reflected at the lower conducting layer during daytime. When there is a single reflection the registered field intensities show a series of regular highs and lows in the course of five minutes which are to be ascribed to the rotation of the plane of polarization in the sky-wave which interferes with the ground wave. The altitude of the reflecting layer varies with the height of the sun. When the path of the ground wave is obstructed by buildings, the fluctuations in amplitude are slight.

Calibration of low audio frequencies

By EARL R. MEISSNER

A CONVENIENT METHOD OF calibrating the low frequencies of an audio oscillator is to use an electric clock. Now most oscillators do not deliver sufficient power to drive the ordinary house clock. However the power stage of an a.-c. radio makes an excellent amplifier, es-

pecially if it will deliver three to four watts which is the power required by most clocks. Of course this power must be delivered at a voltage somewhere near the line voltage previously used by the clock.

Using a clock of the "manual start" type frequencies from 30 to 130 cycles can easily be measured. For frequencies higher than this it is necessary to insert a condenser in series with the clock of such a size so as to tune the circuit to resonance. This extends the range of frequencies up to 240 cycles. The series capacity required at this frequency is approximately $0.045 \mu\text{f}$. The clock is naturally harder to start on the higher frequencies but with practice one learns to do it readily.

The procedure in measuring a frequency is to start the clock and then by means of another timepiece, note the number of minutes recorded by the clock running on the unknown frequency in a given interval of time. The unknown frequency can then be calculated by the relation:

$$f_x = \frac{T_c}{T_a} f_c$$

Where f_x = Unknown frequency in cycles per second.

f_c = Frequency of which clock keeps correct time in cycles per second.

T_c = Interval of time recorded by running on unknown frequency.

T_a = Actual interval of time as acted by watch or other accurate timepiece.

ELECTROSTATIC PIANO

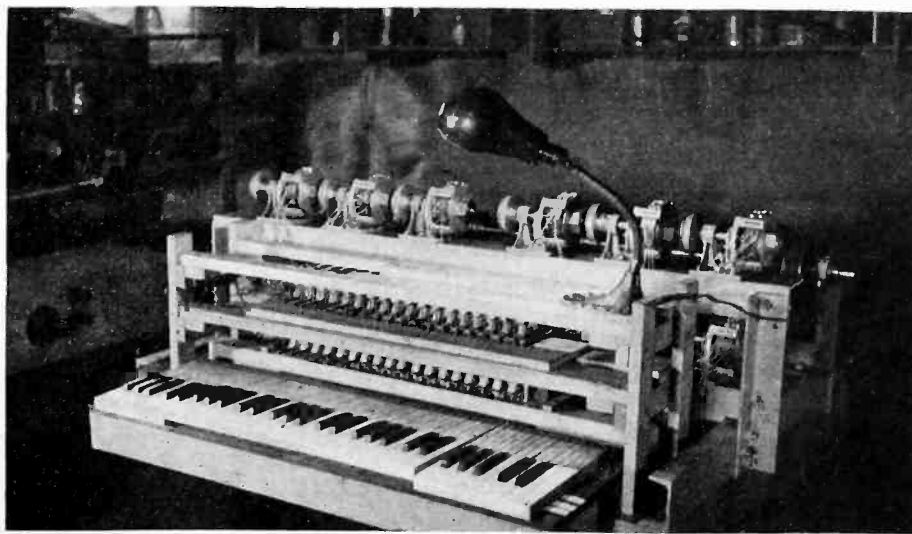

A keyboard musical instrument based upon purely electrostatic principles has been developed by G. W. Demuth, 320 S. Minnesota Ave., Wichita, Kan. Waveforms can be controlled very simply by the shape of the electrodes, and many such generators can be compactly assembled in a keyboard cabinet

electronics

McGraw-Hill Publishing Company, Inc.

330 West 42d Street
New York City

O. H. CALDWELL, *Editor*

Volume VI

—MAY, 1933—

Number 5

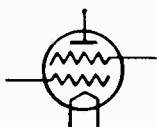

Trial brings out new unexpected possibilities

REPEATEDLY, experience with electron tubes is showing that when an installation is undertaken first for some simple purpose or function, eventually some new and unexpected possibility turns up, and then the new electronic technique proves itself invaluable.

One of the best examples of this is in the control of spot and resistance welding by gaseous tubes. Such tubes were first proposed to take the place of the noisy large contactors that suffered undue wear and tear, and had a certain speed limitation in large sizes. However, once the substitution was made, ingenuity soon found a way of timing the welding cycles to a degree and in a manner that could hardly have been foreseen when planning only the direct substitution.



Styling radio sets for increased sales

RADIO men who have the problem of styling their sets for modern sales conditions, will find that in all classes of merchandise, the persons charged with buying retail stocks recognize that there are three taste levels into which purchasers can be divided. 1. The style leaders, the "smart set," small in numbers and unimportant in volume, yet influential because of their effect on future requirements by the masses. 2. The great middle class, comprised of thrifty, careful, discriminating buyers, who make up by far the largest number and are of chief importance in any merchandising

situation. 3. The "price" buyers who purchase solely on the basis of expediency and price, and to whom quality and artistic design have small appeal. This expediency class also is limited in numbers.

It is the great middle group of sensible, careful purchasers who represent the principal prospects for any type of merchandise. Though conservative, this group responds to artistic design and quality. In the words of a merchandiser who annually places vast orders for a large merchant organization, "Artistic design always pays."



The electron tube— a reliable tool

FACTORY managers and industrialists, potential users of electron tubes, often express their doubts as to the reliability in operation of such tubes. The statement is made that if such tubes would last longer they would prove economical to install and use.

The truth is that tubes have been in service long enough to demonstrate their thorough reliability. The railroads have in operation over 12,000 tubes. Records indicate that these tubes have an average life approaching 3,000 hours. The reason is not difficult to find. A 25-watt incandescent lamp, with a life of 1,000 hours, is considered reliable. It operates at a filament temperature of 4,000 deg. F., has a filament approximately 20 inches long and 0.00118 in. in diameter. The train-control tubes operate at 3,140 deg. F., have a filament two inches long and 0.004 in. in diameter,—about ten times the cross-section of the lamp filament. The sturdiness of this filament and its lower operating temperature are both in the direction of long life, and freedom from filament breakage.

In elevator service, the tubes will probably last much longer than this figure of 3,000 hours. Although the filaments are heated continuously, the tube is loaded only when the elevator is leveling. Furthermore such tubes are much less subject to vibration. It is important too to realize that even if the tube fails, the elevator comes to rest near a floor automatically, and can still be operated as a manually-controlled vehicle.

The completely controlled elevator uses five tubes; the elevator with tube-controlled levelling only uses but three tubes. Thus the expense of tube upkeep is extremely small.



"Facsimile" to the aid of the broadcasters

DIRE plans are apparently underway among the newspaper publishers for the elimination of broadcasting-program material from their reading pages. Unfortunately the newspaper men look upon radio as something competitive, and they are unwilling to give the new agency further support.

Broadcasting needs advance printed programs to which listeners can refer. Mere oral announcements of program features to come are ineffective, except in the case of single outstanding events.

But the radio industry has its own defensive means all ready, in the shape of facsimile reproduction. The radio listener of the near future, when turning off his receiver on going to bed, might merely switch it over onto "facsimile"; the receiver would then go on recording during the night. And on coming down to breakfast next morning, the listener would find issued from his set his morning tabloid newspaper,—headlines, cartoons, radio programs, and all.

In the situation now developing between the broadcasters and the newspapers, radio has facsimile up its sleeve and can put it to good use in delivering printed program schedules, if necessary.



NEWS NOTES

British Television Society—The fourth exhibition of television and photo-electric apparatus of the Television Society of London, was held at the Imperial College of Science, South Kensington, London, April 5 and 6.

Broadcast and receiver engineers meet—Radio problems linking broadcast transmitters and receiving sets were discussed at a joint meeting, April 8 at New York, of the NAB committee under J. A. Chambers, chairman, and the RMA committee under Virgil M. Graham, chairman. E. L. Nelson represented the I.R.E. and R. A. Hackbusch was present for the Canadian R.M.A. Subjects of transmitter "hum" and radio reception standards were covered.

Bill restricting short-wave sets on autos opposed—Radio interests have appeared at committee meetings of the House of Representatives, protesting against the bill introduced by Congressman Louis Ludlow of Indiana, which would restrict the use of short-wave receivers on automobiles, without special license from local police authorities. While the bill is intended to prevent criminals from listening to police-calls, the opposition points out that it would have little effect on criminals, while greatly restricting legitimate users of short-wave receivers.

Electronics division of Hygrade-Sylvania—A complete electronics department for the manufacture of radio transmitters, tubes, special receivers, industrial tubes, and electronic devices of every specialized nature, has been organized by the Hygrade-Sylvania Corporation. The new electronics-division factory is at Clifton, N. J., and the department is headed by William J. Barkley, general manager; D. E. Replogle, chief engineer; Victor O. Allen assistant engineer, and a staff of 22 electronics specialists formerly with the DeForest corporation.

Four observatories to catch Arcturus' light, start Fair—The problem of what to do about starting up the Chicago World's Fair June 1, by light from the star Arcturus, captured on a photocell at the Yerkes Observatory, Williams Bay, Wis., in the event of a clouded sky at that point, has been solved by enlisting the co-operation of three other leading American observatories. The first impulse will come from Arcturus through the Harvard Observatory at Cambridge, Mass. and will light one quarter of the Exposition grounds. This star-light left Arcturus forty years ago at the time of the earlier Chicago World's Fair.

R.M.A. at Chicago, June 6.—Industry stabilization and promotion will be the chief topics before the Radio Manufacturers Association, meeting at the Hotel Stevens, Chicago, June 6. The entire membership is being asked to send two or more representatives to the annual business meeting of the Association and its four groups comprising set manufacturers, tube makers, accessory makers, and sound-equipment manufacturers. On June 5, the last meeting of the present board will be held. Fred Williams, president, will preside at the convention sessions, and Paul B. Klugh of Chicago, will have charge of arrangements for the dinner to be held the evening of June 6.

INFRA-RED "FOG-EYE" TO DETECT ICE-BERGS



Following a nationwide broadcast over the Columbia network, April 17, the infra-red fog-eye developed by Commander Paul H. Macneil of Huntington, Long Island, N. Y., was demonstrated on the Furness liner "Queen of Bermuda" with the aid of British destroyers. A sensitive thermo-pile has its output amplified so that it is sensitive to one fifty-thousandth of a degree Centigrade. Distant ice-bergs, the hot gases from ships' stacks, and exhausts from air-planes can be detected through fog, in the dark.

A single tube inverter

[H. J. REICH, University of Illinois] A feed-back circuit L_2C_2R is added to the thyatron FG-67 for the automatic transformation of d.c. into a.c., so that when the tube becomes conducting and the condenser C_1 discharges through the tube and the primary of the output transformer, a high voltage is induced

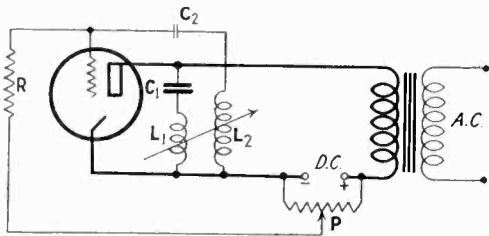

in L_2 , which is preferably an air core coil, and the condenser C_2 and the grid acquire a strong negative charge, which prevents the breakdown of the tube when the plate is once more charged up through the condenser C_1 . The charge on the grid leaks off in the course of time through the grid resistor R , which, therefore, together with C_1 , the turn ratio of the feed-back transformer L_1/L_2 and the degree of coupling, determines the number of cycles. The wave form is greatly improved by the addition of a 0.4 h. air core inductor in series with the output transformer primary. The feed-back arrangement can be replaced by an auxiliary rectifier inserted between L_2 and the negative of the supply, a small internal or external auxiliary electrode being satisfactory.—*Review Scient. Instr.* 4:147-152. 1933.

The new net of German high-power stations

[A. SEMM] The net for covering the 171,000 sq.mi. (twice the size of Idaho) comprises nine stations, of which the Berlin and Hamburg transmitter are not entirely completed. They have a power, unmodulated, of 60 kw., and are capable of 70 per cent straight line modulation; only the Leipzig sender has 100 kw. They are located about 10 miles from the nearest town, in places where ground water is found a few m. below the surface. The high-voltage generators, on vibration absorbing supports, are placed in the basement, and are moreover separated from the transmitter room proper by the amplifier and test room. All towers are of pitchpine to reduce losses, and the emitter is 100 to 200 yd. from the antenna. Four stations have a narrow, vertical fish-net antenna of 100 m. height; Breslau has a straight bronze rope, held straight in

the interior of the 140 m. high antenna tower and crowned by an octagon of 10.6 m. diameter, giving a current node near the top and throwing more energy along the ground. Four of the stations use 150 kw. tubes; Berlin and Hamburg indirectly-heated 300 kw. tubes, the incandescent cathode proper being made of columbium. The newer stations have or will get grid-controlled rectifiers so as to dispense with the induction transformer for voltage regulation.—*Zeits. Ver. d. Ing.* 77:257-264. 1933.

Photoelectric pyrometer and spot welding

[G. MUELLER and H. J. ZETZMANN, Institute of Technology, Berlin.] In spot welding copper the welding times are of the order of 1/25 to 1/50 sec., much too short for measuring the temperatures by the ordinary optical or radiation pyrometers. By letting the radiation from the material to be welded fall upon a caesium phototube with vibration galvanometer followed by an amplifier tube, the change of the temperature from 600 deg. C. to 1,000 deg. C. during the welding process can be ascertained. Filters limit the radiation received to a narrow band in the red. As the currents in the cell are of the order of one $\mu\text{a.}$, careful insulation is required in the entire phototube circuit (amber or quartz). A relay has been added to the welding equipment which stops the machine whenever a certain maximum temperature is exceeded. The indications of the cell can be changed to true temperature by applying Wien's law.—*Zeits. Techn. Phys.* 14:90-94. 1933.

The excitation of light in sodium vapor

[G. HAFT.] While five-volt electrons are just able to excite the yellow sodium line, which is being used in the new high way lighting sources (*Electronics*, August 1932) they excite light in only a small number of collisions with sodium atoms; but the number increases rapidly to one-fifth when the speed of the electron is raised to between 10 and 12 volts; beyond this range it decreases to remain at about one-third of the maximum between 150 and 200 volts. The yield seems to be much larger than in the case of helium and mercury, and the drop in yield with increasing velocity not by far as in other cases.—*Phys. Zeits.* 34:287-288. 1933.

A new method for measuring capacities at high frequencies

[TH. W. SCHMIDT, Silicates Research Laboratory, Berlin.] The method is based upon the property of a tube with tuned grid and tuned plate circuit and feed back coil F that the oscillations start and stop very suddenly, with a corresponding sudden change in the d.c. plate current when grid and plate circuit are gradually adjusted to resonance. Measurements were carried out with quartz-controlled oscillators, the quartz plates giving resonance at 46 m., 100m., 189 and 340 m. A change of 1/10 $\mu\mu\text{f}$ produces a change of about 14 ma. in the plate d.c. When the plate voltage was allowed to drop to one-half, the result changed by only 0.3 per cent, a change in heating current of 10 per

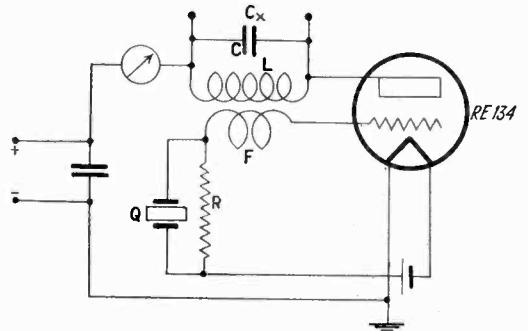

cent gave an error of 0.6 per cent. (Practically the same circuit can be used for measuring inductances). When very small unknown capacities are added to the tuned plate circuit, the values may be deduced from the change in plate current.—*Hochfr. Techn & El. Ak.* 41: 96-98. 1933.

German specifications for radio receivers

THE FINAL DRAFT OF the specifications coming into force Jan. 1, 1934, provide that when the receiver has connections for various supply voltages they must be so arranged that switching from one value to the other can be accomplished only by means of tools. The receiver must bear the manufacturer's name-plate indicating the operating voltage. When power packs are used, they must be screwed to the receiver proper. With 20 deg. C. in the room, no part of the housing shall reach 50 deg. The insulation between the cable and any accessible metallic portion of the receiver, tested by applying 1,500 volt d.c. shall exceed 2 meg., or when testing with the a.c. supply, the current shall not exceed one mil. After this test, 1,500 volts d.c. are applied for one minute.—*El. Techn. Zeits.* 54: 315-318. 1933.

The effect of X-rays on barrier-layer cells

[K. SCHARF and O. WEINBAUM] When 80-kv. X-rays fall upon copper-cuprous oxide or selenium cells, the photoelectric current and voltage produced are of the same order as when the cells are exposed to light. With X-rays of such a wave-length that the intensity is halved after passage through 0.03mm. copper, the initial intensity being equal to one roentgen per sec., the current was about $0.07 \mu\alpha$ with a front wall cell and $0.25 \mu\alpha$ per sq.cm. with a selenium cell when the resistance in the outer circuit amounted to 300 ohms. Cells from different manufacturers differ in response.

Similar work is also reported by P. R. Gleason, Colgate University, who used 200 kv. electrons and hopes to be able to develop the cells as a convenient means for measuring X-ray intensities.—*Zeits. f. Physik*, 80: 465-482. 1933.

The fight against man-made static

- (1) *Rundfunk Stoer befreiung*, by H. Keller. Published by Deutsch-liter, Institut, Berlin, 1932. 80 pages, 88 fig., 50 cents.
- (2) *Rundfunk Entstoeerungstechnik*, by F. Conrad. Published by Weidmannsche Buchhandlung, Berlin, 1932. 56 pages, 47 fig., 30 cents.
- (3) *Rundfunk Stoerungsfrei*, by E. Schwandt. Published by Hachmeister und Thal, Leipzig, 1932. 74 pages, 54 fig., 20 cents.

THE FACT THAT THREE BOOKLETS on this subject appeared at the same time, one of them, though perhaps not the best one, sponsored by the German Radio Engineering Society, indicates how serious the question is despite the fact giant stations are the fashion in Europe.

Storage batteries 1930-1933

[L. JUMAU] The article deals with recent French patents on the preparation of the lead plates (16 patents), the deposition of the active material (13 patents) by centrifugal and chemical methods, the electrolyte (14 patents), accessories (32 patents, mainly on cases, stoppers, separators, connectors protected according to one patent by a paste containing 1,000 grams of sodium carbonate and 1,200 grams of automobile oil), methods of mounting (37 patents, to prevent spilling, etc.), storage batteries other than lead batteries (40 patents relating to sulphuric acid and copper, zinc, cadmium, lead-zinc, alkaline batteries), charging (34 patents, including a switch cutting off the secondary when

radio batteries are charged through a copper oxide rectifier).

In addition, an article by C. Fery (*Revue gen. del' Electr.* 33:313-318, 1933) describes how by having the negative plate surrounded by hydrogen at all times while leaving the positive plate in contact with air, sulfation is greatly reduced.—*Revue gen. El.* 33:339-352. 377-392. 413-424. 1933.

Electron emission from oxide-coated filaments

[M. BENJAMIN and H. P. ROOKSBY, Research Laboratory, General Electric Co., Wembley; W. G. Burgers, Philips Research Laboratory, Eindhoven.] Flashing at high temperatures, or exposure to air at ordinary running temperature, is liable permanently to spoil oxide-coated filaments. Nickel in the form of wires 0.044 mm. diameter, cleaned and annealed in hydrogen at 700 deg. C., was coated by passing it through a series of baths containing a suspension of strontium and barium carbonates and sintered at 700 deg. C. in an atmosphere of carbon dioxide (coating weight 0.25mgm. per 20 cm. length of wire). X-ray analysis of the structure shows that the loss of emission is associated with a loss of barium oxide in preference to strontium oxide. This was also shown by work carried out at the Eindhoven Laboratory. The filament may be regenerated if, instead of flashing, the surface layer (rich in

strontium oxide) is sputtered off by passing a discharge through the tube.—*Phil. Mag. J. of Science* 15: 810-829. 1933. *Zeits. f. Physik* 80: 352-360. 1933.

Wehnelt cylinder in relation to electron direction

[F. HAMACHER, Aachen Institute of Technology] The electrons are received upon a luminescent calcium tungstate plate at 12 cm. from the straight or bent tungsten single crystal wire of 13 mm. length and 0.2 mm. diameter. The width of the trace of the electrons upon the screen, 2 mm. at 12 cm. is proportional to the distance from the source. The emission is limited to a narrow region, one-tenth of the length. Above 1,000 volts the electrons leave the wire in a true radial direction, and in order to get a strong sharp pencil of charges through a diaphragm, the direction of the electrons must be changed by surrounding the V-shaped filament with a negatively charged cylinder. When the distance from the tip of the filament to the nearest edge of the cylinder is varied, while the diameter of the trace upon the screen is kept constant by adjusting the cylinder voltage, the current density in the trace reaches a sharp maximum for a certain distance, about 8 mm. in the case described, a point which is useful in the construction of cathode-ray tubes.—*Arch. f. Electro-techn.* 27:47-56. 1933.

Electronic device for temperature measurements

[H. ESSER and W. GRASS, Aachen Institute of Technology.] Vacuum all-metal calorimeters, in which the hot body drops into a metal container to which it gives its heat, are very reliable for measuring the specific heat of solids at high temperatures, but when oxides or carbides are used, delays and losses are considerable. The remedy is to measure the final temperature of the metal container not by means of ther-

mometers or thermopiles, but by its expansion. To this end it is made to form one side of a condenser (103) which is part of the tuning circuit of a beat frequency oscillator. The diameter of a copper cylinder of 8.5 cm. changes by 0.14 millicm. for a degree C., and this change is readily detected in the pitch of the heat frequency when 30 m. waves are used. A change of 3/1,000 degree centigrade produces a loss or an increase of 10 cycles. The calorimeter-condenser is placed between two much larger condensers of 8,000 μf .—*Archiv f. Eisenhüttenwesen*, 6: 353-357. 1933.

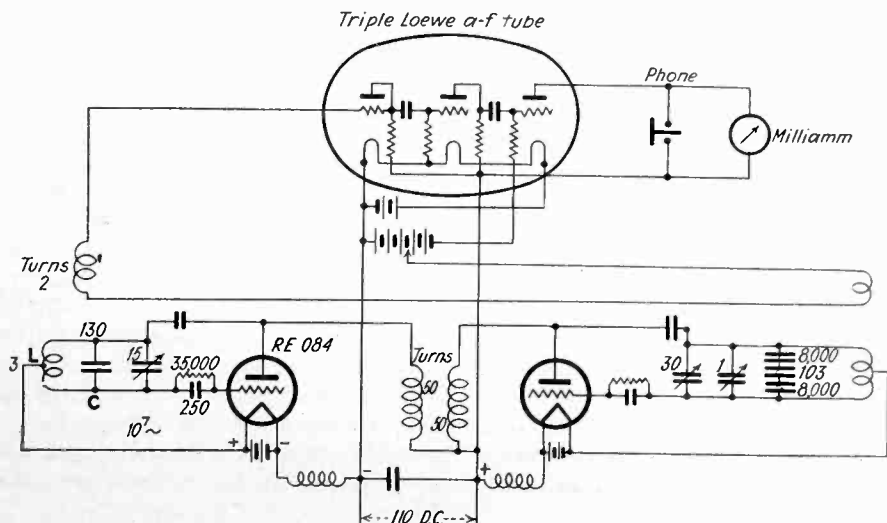

+ NEW PRODUCTS

THE MANUFACTURERS OFFER

Complete radio socket

THE CINCH MANUFACTURING CORPORATION, 2335 W. Van Buren St., Chicago, Ill., is now making a complete radio socket in one part that does away with the handling of two extra rivets and the use of riveting machines. It is only necessary to punch a hole in chassis, insert socket and a short turn will lock it securely and rigidly in place.

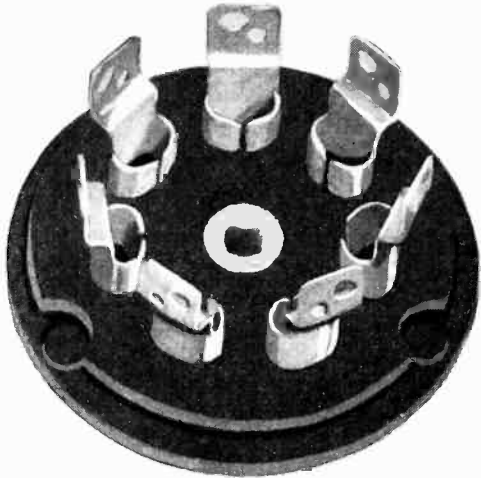

The Cinch socket, to be known as model 44, is available for four, five, six and seven prong tubes. Booklet illustrating the complete line of tube sockets, radio plugs, laminated plugs, binding posts, tip jacks, soldering lugs, mounting strips and metal stampings may be had upon request.—*Electronics*, May, 1933.

Pickup and amplifier for musical instruments

WITH HEADQUARTERS at 111 Fulton St., Grand Rapids, Mich., the Musical Arts Laboratories' system of pickup and amplification for stringed instruments involves the use of a small pickup unit and a specially designed amplifier.

The pickup unit is about the size of a silver dollar, but a trifle thicker. It weighs less than an ounce and is interiorly installed in fretted instruments, and exteriorly and indirectly placed for use with bowed instruments.

It is usable in any fretted instrument and in no way affects the natural tone character and volume of the instrument. When connected with the amplifier, the tone delivery from the amplifier is in addition to the natural tone delivery of the instrument itself. In other words, a fretted instrument with the device installed can be played in exactly the same way and with exactly the same results as heretofore, whether with or without amplification.

Installation in fretted instruments involves no external change in the instrument, except that in the hole where the end button is ordinarily inserted, there is placed a small plug-in receptacle into which the connecting cord is plugged or detached, as instrument is used for amplified playing or without.

For the violin and viola, the pickup device is installed in a special chin rest with the plug-in cord attachable or detachable. With the cello and double bass, the pickup is installed in a special end pin which is used instead of the regular end pin.

The amplifier cabinet, dimensions 11 in. by 11 in. by 4½ in., contains amplifier and speakers. It is attractively designed and finished, and weighs about 10 lb. A single cord extends from amplifier to instrument and another from amplifier to current connection. Amplifier is usable on any 110-volt current, whether d.c. or a.c. —*Electronics*, May, 1933.

Voltage tester

A VOLTAGE TESTER that requires no lamps and registers accurately the voltage as well as indicating whether it is a.c. or d.c. is announced by the Square D Company, Detroit, Mich. The tester is inclosed in a rugged fiber case so that

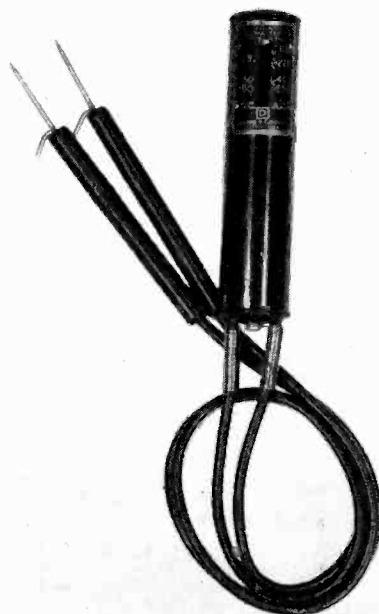

there is no danger to the operator or to the tester.

It is simple to operate, it is claimed; all that is necessary is to place one wire in each side of the circuit and the indicator shows what the voltage is. A.c. voltages are shown by the slight vibration of the indicator.—*Electronics*, May, 1933.

Self-tapping cap screws

AFTER THREE YEARS' USE, at first experimentally and then in regular production, in some of the largest metal-working plants in the country, these Hex-head-hardened self-tapping cap screws now take their place as a member of the Parker-Kalon group of time- and labor-saving fastening devices. Like other types of Parker-Kalon self-tapping screws, these cap screws eliminate tapping; they form their own



thread in the material . . . as they are turned in. The elimination of this troublesome and costly operation results in large savings and other advantages besides.

The screws are extensively used for making fastenings to sheet metal from 24 gauge to 10 gauge; to steel plate and structural shapes up to ½ in. thick, and to solid sections of brass, bronze, aluminum and die castings, slate, transite board, ebony asbestos, etc.

They are made in a complete range of sizes from No. 6 to ½-inch diameter. The Parker-Kalon Corporation, 200 Varick St., New York City, offers to send free, test samples to any design engineer, production official or plant executive, together with complete engineering information.—*Electronics*, May, 1933.

Resistor heating material

DRIVER-HARRIS COMPANY, Harrison, N. J., announces a new series of Nichrome alloys, to be known as "Nichrome V," the latest step in the development of nickel-chromium alloys.

Twenty-five years of experience in dealing with problems of heat resistance equips the company's technical staff to meet the requirements for longer life, quicker heating and greater overload capacity. This growing demand for increased speed, high temperatures and longer life has led to the introduction of "Nichrome V."

The performance of "Nichrome V" on the life-test board has far exceeded the expectations of the engineers, inasmuch as it was substantially more than that of any material heretofore furnished.—*Electronics*, May, 1933.

Time-delay relays

THE WARD LEONARD ELECTRIC COMPANY, Mount Vernon, N. Y., is marketing a new motor-driven time-delay relay designed to produce a definite time interval between two different operations. The relay consists of a small constant-speed driving motor, a gear train, a tripping arm and a magnetic operated clutch between the trip arm and gear train. The time interval may be readily adjusted by changing the arc of travel of the trip arm. Various time ranges are provided by standard and special gearing. Standard gearing affords

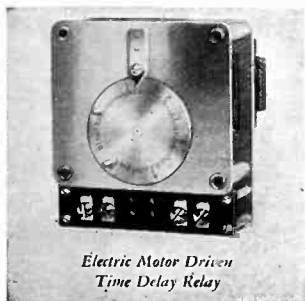

three time ranges: 4 to 60 seconds, 20 seconds to 5 minutes and 2 minutes to 25 minutes.

The total maximum input is 5 watts at 110 or 220 volts, 60 cycles, contact capacity 2 amperes a.c. or 0.5 amperes d.c. The size is approximately $3\frac{3}{8}$ in. by $3\frac{1}{2}$ in. by 3 in. deep.—*Electronics, May, 1933.*

Rubber rule

HALLOWAY KILBORN of the Kilborn & Bishop Company, 196 Chapel St., New Haven, Conn., manufacturers of tools, has developed a rubber rule which has a number of applications for measuring objects, counting, and solving various mathematical equations. A strip of highly-elastic rubber is marked off into divisions, and when stretched, has the property that all its divisions are equally expanded. By applying a given division to a known unit, then the total expanded rule applies proportionately to the material to be counted or measured. Thus the rubber-rule can be used as a multiplier or divider. In other forms it can also be used to derive logarithms, solve equations, and work out mathematical problems.—*Electronics, May, 1933.*

Cellophane indoor aerial

A NOVELTY IN INDOOR AERIALS is Cello ribbon antenna made by Freyberg Brothers, 11 W. 19th St., New York City. Instead of the usual unsightly wire, this new type antenna is a thin flat ribbon covered with colored cellophane. It is said to secure better reception than other types of indoor antenna because of its large surface area and its cellophane insulation.

A further advantage lies in the decorative quality of the cellophane covering itself. This comes in a variety of colors and can be harmoniously adapted to any decorative color scheme.

Cello ribbon antenna is extremely flexible and may be fastened around moldings or baseboards without difficulty.—*Electronics, May, 1933.*

Fitted glass filters

UTILIZING THE PROPERTIES OF metallic mercury and of fritted glass filters, a new valve developed for introducing gases at low pressures into highly evacuated systems, avoids the uncertainty and inconvenience of plug cocks and other similar valving arrangements. Fritted glass filters with very fine pores will not permit the passage of liquid mercury even at high pressure differences on account of the high surface tension of the mercury, but they are highly permeable to gases and offer very low resistances to gas flow. In addition to this important property, such filters, being made entirely of chemically resistant glass, are not wetted by mercury so that when two filter faces are brought together the mercury between them is squeezed away, leaving a free passage for gas from one to the other. These facts have been applied to the accurately regulated introduction of low pressure gases into high vacua, as required particularly in the radio and incandescent lamp industries, in the apparatus distributed by the Fish-Schurman Corporation, 230 E. 45th St., New York City.—*Electronics, May, 1933.*

Turntable adapter

THE "DISKADAPT" IS THE NAME of a new development for making old turntables instantly adaptable to new or old speed. It plays the new long-playing records at $33\frac{1}{3}$ r.p.m. or, by the simple pressing of a lever, the regular old-type records at 78 r.p.m. Diskadapt fits all makes of electric or spring-



driven phonographs. Anyone can install it in a few minutes. A simple, rugged mechanism is concealed beneath its smartly finished disk. Diskadapt is made, from raw material to finished product, in the factory of the New Era Specialties Corporation, 21 Spruce St., New York City.—*Electronics, May, 1933.*

Relay for radio circuits

THE SIGNAL ENGINEERING COMPANY, 142 W. 14th St., New York City, has developed a new junior type C-7 relay which has many radio circuit applications, owing to the unique feature of the dual contacts, making it available for two-circuit control work without the use of pigtailed on the arms.

This C-7 relay is also equipped with condenser and resistor mounted on the bakelite base of the unit, giving a reading of 9 milliamperes through the control circuit, while the contacts of the relay will handle loads up to 15 amperes.

This combination makes an ideal device for crystal oven temperature control in conjunction with the sensitive adjustable mercury-type thermal temperature control device for such crystal ovens, and the 9 milliamperes current flow is so slight that no harm is done to the sensitive column of mercury used in such critical temperature control devices. The use of the condenser in the coil circuit of the relay practically eliminates all trace of sparking, which is harmful to sensitive instruments.—*Electronics, May, 1933.*

Manufacturers' bulletins and catalogues

Resistance units—Ohmite vitreous-enameled and cement-coated resistors are featured in the April Ohmite News, issued by Ohmite Manufacturing Company, 636 North Albany Ave., Chicago, Ill.

Photo-cell alarms—"Intellect-A Ray" photo-cell alarm and industrial units are described and illustrated in new circulars issued by the Intellect-A-Ray Corporation, Singer Building, Pasadena, Calif.

Direct-current amplifier—The amplifier unit developed in connection with the Macneil all-weather sextant, an amplifier which has many other applications, is described in a special circular just issued by Allen DuMont Laboratories, Upper Montclair, N. J.

Sound-on-film projectors and cameras—Recording cameras, amplifiers, projectors, sound-heads, photo-cell kits, and tubes are described in new bulletin of Herman A. DeVry, Inc., 1111 Center Street, Chicago, Ill.

Radio contact pins—The Bead Chain Manufacturing Company, Bridgeport, Conn., announces having granted a license for the manufacture of radio contact pins, also molding them into radio tube-bases, to the Waterbury Brass Goods Corporation, Waterbury, Conn.

Electro-dynamic loud-speakers—All Jensen electro-dynamic speakers are described in a new circular issued by the Jensen Radio Manufacturing Company, 6601 South Laramie Avenue, Chicago, Ill. Special features include the new Orthodynamic model, and the new Model T-3 in the small-speaker class.

Wire-wound fixed resistors—Candohm resistor units are described with complete specifications in the new Candohm technical catalog 4-1-33, issued by the Muter Company, 1255 South Michigan Avenue, Chicago, Ill.

Selenium cells—The Acousto-Lite cell for burglar alarm, light-beam control, chemical density measurements, sound pickup, etc., is described in a new bulletin issued by The Acousto-Lite Corporation, 2908 South Vermont Avenue, Los Angeles, Calif.

Condensers—Tubular condensers, by-pass condensers, and uncased condensers are described in a circular giving working voltages and other specifications, issued by the Cosmic Products Corporation, 2157 Prospect Avenue, New York City.

U. S. PATENTS

IN THE FIELD OF ELECTRONICS

Photo Cell Application

Color matcher. Method of matching the color of a luminous body to that of a body of known color characteristics by alternately projecting upon the photocell light rays from the opposite halves of the spectrum of the luminous body of known color which will produce equal electrical current in photocell circuits; substituting for the luminous body the body whose color is to be matched and altering the color of the body until the light ray thus projected produces in the photo cell circuit two equal currents. C. H. Sharp, White Plains, N. Y. Filed Sept. 6, 1929. No. 1,898,219.

Oscillation generators. Patent Nos. 1,894,636 and 1,894,637 to G. B. Scheibell assigned to Wired Radio, Inc., on methods for producing oscillation, one using a photocell and an electrostatic light cell and the other using a cathode ray tube.

Picture transmission system. Use of a photocell having an anode, cathode and control electrode. C. A. Culver assigned to Wired Radio, filed May 1, 1929. No. 1,898,080.

Television system. Projecting an image upon a photoelectric screen, then interrupting the light beam forming the image and scanning the screen. F. C. P. Henroteau, Ottawa, Canada. No. 1,903,113. Also No. 1,903,112.

Synchronizing system. Production at the transmitting station of a continuous cycle of signals of predetermined duration in order and strength variable in accordance with areas of an image to be transmitted. C. F. Jenkins assigned to Jenkins Laboratories, Inc. Reissue No. 18,783.

Radio Circuits

Superheterodyne. Method of maintaining a constant frequency difference between the locally generated and signal representing oscillations. V. C. MacNabb assigned to Atwater Kent Mfg. Co. Filed Nov. 5, 1931. No. 1,896,825.

Directional system. An automatic steering device for dirigible craft comprising the gyroscope and a radio responsive means for controlling the torque about the lower frontal axis of the gyroscope. E. A. Sperry, Jr. and B. A. Wittkuhns assigned to Sperry Gyroscope Company. No. 1,896,805.

Audio amplifier. Push-pull amplifier whose secondary is resonant to a frequency near the upper end of the audio frequency range and whose primary circuit is resonant to a frequency near the lower end of the range. A. H. Grebe, Hollis, N. Y. Filed Dec. 24, 1930. No. 1,895,792.

Rejector system. In a superheterodyne circuit to eliminate undesired signal frequencies, differing from the desired signal frequencies by slight intermediate frequencies. V. C. Mac-

Nabb assigned to Atwater Kent Mfg. Co. Filed July 23, 1930. No. 1,895,809.

Amplifying system. An oscillatory tube amplifier with feed back for preventing oscillation over the range of frequencies with which the amplifier is to work and additional feed back to prevent oscillation at higher frequencies. K. W. Jarvis, assigned to W. E. & M. Co. Filed July 17, 1926. No. 1,899,758.

Corkscrew radiation. Method of rotating the plane of polarization of a directly emitted wave to obtain directive corkscrew radiation and wobbling the directivity of the radiation at a frequency lower than the rotative frequency. N. E. Lindenblad, assigned to R.C.A. Filed Aug. 17, 1927. No. 1,898,058.

Amplification, Detection, Etc.

Current source. Apparatus for supplying the filaments of thermionic tubes having different amplification factors with a source of pulsating direct current; a means is provided for connecting the filament of the high amplification tubes in series through an inductance and resistance and for connecting the remaining tube filaments through the resistance. Rudolf Rechnitzer assigned to Telefunken Gesellschaft, Berlin, Germany. Filed Nov. 14, 1929. No. 1,902,894.

Negative inductance. An automatic device having reactance characteristics of opposite signs to that of an inductance, such reactance varying in direct proportion to frequency in accordance with the formula of reactance equals $-2\pi fL$, f is the frequency and L is a constant. M. M. Dolmage, Washington, D. C. Filed October 4, 1928. No. 1,903,610.

Audion amplifier. Method of automatic volume control which comprises impressing upon the amplifier input circuit two discrete d-c potentials which vary automatically and according to different functions of the magnitude of the incoming electrical wave. One of these potentials is effective for weak signals and the other for strong signals. A. W. Barber, Boonton, N. J. Filed Feb. 12, 1931. No. 1,903,542.

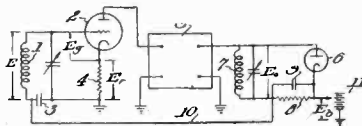

Electric regulator. An electric machine having a stator and a rotor, a tuned circuit responsive to changes in a characteristic of the machine and a vacuum-tube regulator responsive to said circuit. H. M. Stoller assigned to W. E. Co. Filed June 11, 1919. No. 1,895,498.

Electrical control system. For maintaining a predetermined speed ratio between members of a system having several rotatable members by using light-

sensitive means and by moving the light-sensitive means in accordance with the speed of one of the members. John Hammond, Jr., assigned to G. E. Co., No. 1,895,925.

Synchronizing system. Apparatus for determining and equalizing differences in the positions of two shafts located at a distance apart comprising a network, a rotary transformer, push-pull amplifier tubes, etc. Johannes Vopel and Rudolph Oetker, Berlin, Germany. No. 1,895,240.

Oscillator. An oscillator-modulator arrangement using a tube with two grids and a method for neutralizing the grid to cathode capacity of the tube relative to the oscillation frequency input whereby the presence of a tuned input circuit will not affect the oscillation frequency voltage. V. E. Whitman, New York, assigned to Hazeltine Corp. Filed April 9, 1932. No. 1,893,813.

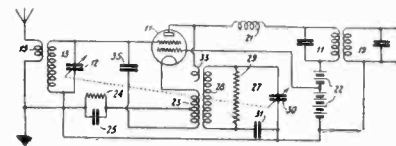

Power applications, etc.

Weak current indicator. Device for switching considerable current by extremely weak current comprising gas discharge tubes with main electrodes and an auxiliary electrode. The energy supply connected to the main electrode is ordinarily too weak to produce ionization and an auxiliary potential upon the auxiliary electrode of very low potential starts the discharge. R. H. H. Geffckin and R. H. Richter, Leipzig, Germany. Assigned to Radio Patents Corp. Filed Nov. 12, 1924. No. 1,898,046.

Reactance-controlled relay. A self-modulating, high-frequency oscillator with a relay in the plate circuit vibrating at the frequency corresponding to the modulation frequency. P. S. Edwards and C. D. Barbulesco, Dayton, Ohio. Filed Oct. 2, 1929. No. 1,898,432.

A-C generator. Circuit using a vapor electric valve and a condenser charged through a resistance and discharging from cathode to grid. C. S. Franklin and D. A. Cutler, assigned to G. E. Co. Filed Jan. 28, 1931. No. 1,898,827.

Modulation system. Method of modulating a gaseous cold-cathode tube. August Hund, assigned to Wired Radio, Inc. Filed Nov. 2, 1931. No. 1,898,486.

A-C generator. Use of the discharging condenser for generating a periodic current of approximately sine wave form. B. D. Bedford, assigned to G. E. Co. Filed Jan. 28, 1931. Renewed Sept. 10, 1932. No. 1,898,932.

Glow lamp circuit. Method of connecting a glow lamp to a two-rectifier circuit. M. J. Druyvesteyn, Holland, assigned to R.C.A. Filed Dec. 21, 1929. No. 1,899,021.

Photocell amplifier circuit. Method of connecting the output of a light-sensitive cell to a triode amplifier tube. T. H. Nakken, assigned to Nakken Patents Corp. Filed May 21, 1929. No. 1,899,712.

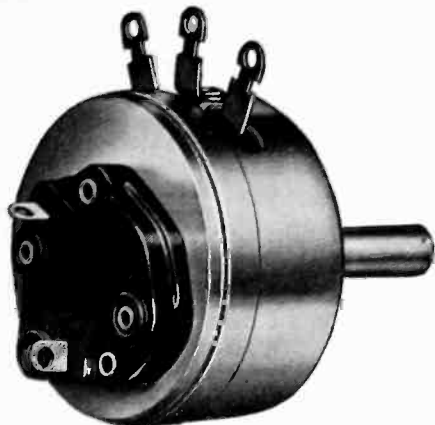

No. T20 Series, with switch.

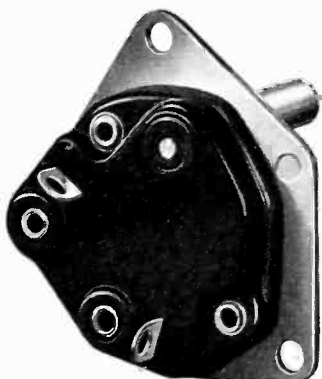

No. 11 Switch, for panel mounting
No. T, for unit mounting.

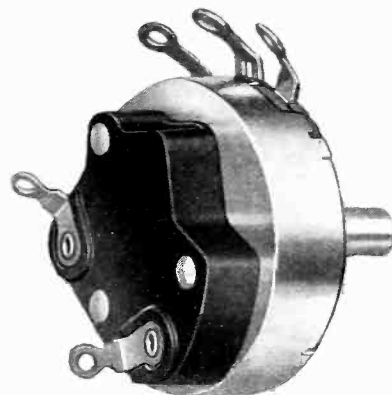

No. T70 Series, with switch.

Why not discuss your Volume and Tone Control problems with us?



Lowest Operating Torque and Contact Resistance

A lot to claim — a lot to deliver — yet our No. 11 *does* have these outstanding features. Also has smallest knob movement, positive kickoff, double bearing "cold" cam, and a lot of other advantages — plus Underwriter's Laboratories' Approval for 3 A, 125 V., 1.5 A, 250 V, AC or DC. Write for samples. You'll find our No. 11 even better than we claim!

IT is quite possible that we can help you solve some of those Volume and Tone Control problems of yours . . . We've done it for a number of other set manufacturers . . . Some of them have been just a little surprised—perhaps *astonished* would be a better word—to learn just how thoroughgoing and painstaking we are . . . A number of our set manufacturer friends have told us we helped them greatly in this particular phase of their production. And we'd like to help you, too!

No small share of our success in the development and manufacture of superfine wire wound and carbon element type variable resistors is due to our having constantly maintained a 100% Engineering and Research Department. And when we say 100% we mean just that! It is on its toes every hour of the working day—and on numerous occasions far into the night—to help folks like you obtain properly designed volume and tone controls . . . incidentally, our Engineering Department is second to none in the entire industry.

We want to help. How can we do so? If you will write us fully, sending specifications or chassis, we'll submit samples . . . efficiently engineered . . . promptly . . . and with no obligation whatever! May we hope to serve you soon?

CHICAGO TELEPHONE SUPPLY CO.

HERBERT H. FROST, Inc.

SALES DIVISION

General Offices ELKHART, INDIANA and Plant

BRITISH PATENTS

IN THE FIELD OF ELECTRONICS

Radio Circuits

Remote control system. A super-heterodyne type of receiver in which the local oscillator is distinct from the receiver proper and may be used at any point in the dwelling remote from the receiver itself by using the power lines in the house to transmit the local oscillator output to the mixing tube in the receiver. Thus the portable oscillator can be plugged into a receptacle at any point in the house and can, from this point, control the receiver. At the receiver the mixing tube with its associated power rectifier is left permanently connected to the power lines so that it can be energized by the remote control tube. When the output of the remote control oscillator is fed into the line, it changes the plate current of the mixing tube and this change will operate a relay to turn the power into the set proper. A. S. Blatterman, 1304 Wannamassa Drive, Asbury Park, N. J. No. 383,189.

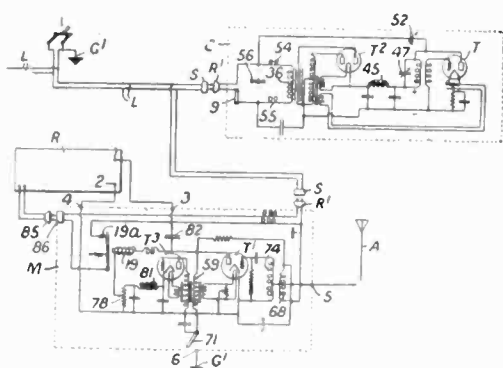

Railway signalling. Apparatus for transmitting to and receiving from the rails electro magnetic oscillation whereby braking and warning signals are given when two trains approach too closely. A. Modrach Belgrade. No. 384,982.

Super-regenerative receiver. The quenching frequency is arranged to render the tube alternately operative. The signal is applied to the tube in push-pull while the tubes are each back coupled in opposite sense. Walter van Roberts, assigned to Marconi Co. No. 385,525.

Automatic volume control. Use of dry surface contact type of detector for providing automatic volume control in a radio receiver. A. V. Tomlinson, Union Switch & Signal Co. No. 385,619.

Detector. Uses dry surface contact type of detector with sufficiently high capacity to act as a storage condenser, when the applied potential is in the high resistance direction, and the rectified signal is applied to the grid of a thermionic tube or other load. A. V. Tomlinson, Union Switch & Signal Co. No. 385,998. See also No. 385,997; same inventor and assignee.

Infra-red signalling. Method of signalling between ships or airplanes or between either of these and land stations by the use of infra-red, heat or ultra-short wireless rays. T. M. Hawker. No. 384,325.

Super-regenerator. A receiver designed especially for compactness and portability. Tapped input and output inductances are coupled together and the input is tuned by variable condenser in series with a variable resistance. The tube is designed to operate with three-volt heating voltage and 4½ volts anode supply. W. V. B. Roberts, Marconi Co. No. 382,881.

Variable-mu tubes. Method of varying the grid turns so that various portions of the grid structure have different orders of control over the space current. Boonton Research Corp. No. 382,945.

High-frequency oscillators. Use of a high frequency field for cracking heavy oils comprising a transformer, a condenser and a quenched or rotary gap. Aktis, Akt-Ges., Switzerland. No. 383,384.

Gaseous amplifier. A valve generator or amplifier having an auxiliary discharge serving as an electron source with means for feeding back energy from the output circuit into the auxiliary discharge circuit. Telefunken. No. 383,807.

Apparatus for the blind. A method of reproducing printed matter in a form suitable for touch reading by blind persons by scanning sections of the matter with light rays and forming indented characters. R. E. Naumburg, Cambridge, Mass. No. 383,835.

Superheterodyne circuits. Method of eliminating interference such as the image frequency in a superheterodyne receiver. J. K. Johnson, Hazeltine Corp. No. 384,544.

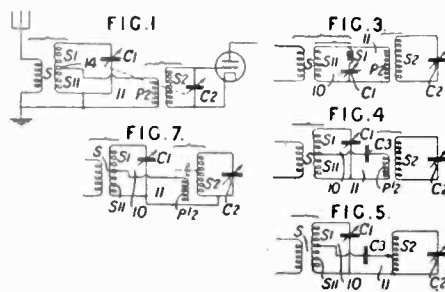

Coupling circuit. A fixed capacity shunted by an inductance is coupled to another shunt circuit with variable capacity by means of a fixed condenser. The primary circuit is tuned to a fixed frequency below the lowest frequency to which the second circuit is to be tuned. Substantially uniform overall transmission characteristics may be obtained. D. E. Harnett, assigned to Hazeltine. No. 383,987.

Frequency modulation. In a frequency modulated transmitter accidental amplitude modulation is neutralized by applying intentional amplitude modulation of opposite phase. W. Albersheim, Marconi Co. No. 383,412.

Stable oscillator. The frequency of an oscillator is kept constant despite changes in anode voltage by providing an auxiliary anode and applying to it a voltage proportional to that of the main anode whereby any frequency change due to change of anode voltages is counterbalanced by a frequency change of equal amount but of opposite phase due to alteration of the auxiliary anode voltage. J. B. Dow, assigned to Wired Radio, Inc. No. 383,981.

Discharge tube. A cathode for a thermionic discharge tube is provided with an emissive layer comprising barium or another metal of the alkali or alkaline earth series in the free state and a small amount of one or more alkali or alkaline earth metal compounds having, at the working temperature, a higher electrical conductivity than the monoxide of the emissive metal present in the free state. Barium sulphide and barium cyanide are specified as compounds suitable for use with barium and the examples given relate to the use of barium sulphide with or without other compounds as follows: (1) Barium sulphide is applied to the cathode and barium is atomized upon it in known manner. (2) A minute quantity of sulphur vapor is introduced into the tube either prior to or immediately after atomizing barium in excess on to the cathode. (3) Barium sulphate is applied to the cathode and barium in excess is atomized within the tube so that some of it reacts with the barium sulphate to form barium sulphide and barium monoxide. (4) A tungsten filament is coated with potassium bisulphate by passing it through the molten compound at 270-300° C. and fitted in the tube, the bisulphate is converted into the normal sulphate by heating the filament during the pumping operation, and barium in excess is atomized on to the cathode from a mixture of barium oxide and aluminum, heated at some part of the tube remote from the cathode, so that some of the barium reacts with the potassium sulphate to produce a mixture of the oxides and sulphides of potassium and barium. (5) A small amount of barium is atomized on to the cathode, a small amount of hydrogen sulphide is introduced into the tube, the excess of hydrogen sulphide and the hydrogen formed are pumped off, the tube is sealed and barium in excess is vaporized and deposited on the cathode in known manner; in this case the electrodes other than the cathode are preferably of a metal, such as molybdenum or tungsten, not readily attacked by hydrogen sulphide. (6) Sulphur dioxide is used in place of the hydrogen sulphide in (5) with the advantage that the electrodes may be of other metals such as nickel; in this case the reaction of sulphur dioxide with small quantities of barium oxide present produces barium sulphide and barium sulphate and the latter reacts with some of the metallic barium as in (3). Calcium strontium and potassium are also specified for use as emissive metals in place of barium. D. S. Loewe and O. Emersleben, Berlin. No. 380,835.